

TRIO
LIGHTING FOR YOU



OUTDOOR
AUSSENLEUCHTEN | 2026
OUTDOOR LUMINAIRES

Mehr Komfort, mehr Sicherheit – die neuen Funktionen unserer Außenleuchten.
More convenience, more safety - the new functions of our outdoor lights.



MOTION SENSOR MULTICONTROL

Der integrierte Bewegungssensor der Hauptleuchte kann eine bestimmte Anzahl weiterer Leuchten mitsteuern. Die zusätzlichen Leuchten empfangen das Signal der Hauptleuchte und benötigen daher keinen eigenen Sensor.

The integrated motion sensor of the main light can also control a certain number of additional lights. The additional lights receive the signal from the main light and therefore do not require their own sensor.

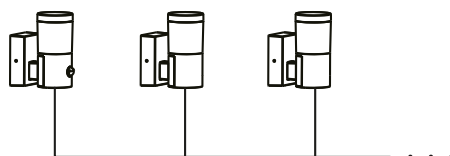

max. 8 pcs.



CONNECTOR BOX

Der Anschlusskasten dieser Leuchten ist so ausgelegt, dass er zwei Anschlussleitungen aufnehmen kann. Dadurch lassen sich mehrere Leuchten problemlos in Reihe schalten.

The connection box of these lights is designed to accommodate two connection cables. This means that several lights can be easily connected in series.

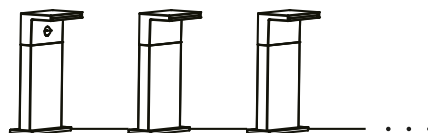

max. 8 pcs.



Robuste Außenleuchten für Küstenregionen · Robust outdoor lights for coastal regions

Leuchten, mit dem Label „Seaside Ready“, sind die perfekte Wahl für alle, die in maritimen Umgebungen leben. Dank hochwertiger Materialien und spezieller Oberflächenbeschichtungen trotzen sie selbst den härtesten Bedingungen an der Küste. Salzhaltige Luft und wechselnde Witterung können diesen Leuchten nichts anhaben.

Luminaires with the "Seaside Ready" label are the perfect choice for anyone who lives in a maritime environment. Thanks to high-quality materials and special surface coatings, they can withstand even the harshest conditions on the coast. Salty air and changing weather conditions are no match for these lights.



10 Jahre Garantie auf Korrosionsschutz bei Leuchten aus pulverbeschichtetem Aluminium. Ausgenommen sind Ausbleichen der Oberfläche sowie technische Komponenten.

10-year guarantee on corrosion protection for luminaires made of powder-coated aluminum. This excludes fading of the surface and technical components.



15 Jahre Garantie auf Korrosionsschutz bei Leuchten aus feuerverzinktem Edelstahl. Ausgenommen sind Ausbleichen der Oberfläche sowie technische Komponenten.

15-year guarantee on corrosion protection for luminaires made of hot-dip galvanized stainless steel. This excludes fading of the surface and technical components.

Inhaltsverzeichnis · General Index

Index général · Algemene index · Índice general ·

Indice generale · Index general · Yleisindeksi · Ogólny indeks



12

TRIO AUSSENLEUCHTEN

TRIO OUTDOOR LUMINAIRES

120

REALITY AUSSENLEUCHTEN

REALITY OUTDOOR LUMINAIRES

144

LED-SOLARLEUCHTEN

LED-SOLAR LIGHTS

178

OUTDOOR LIVING

OUTDOOR LIVING



Serienübersicht · Family overview

Aperçu par famille · Overzicht per familie · Vista general por familia ·

Panoramica per famiglia · Prezentare pe familia de produse · Perheen yleiskuvaus · Przegląd rodziny



ADAJA	40	MAYENNE	43	ACORA	169	MORO	156
ADOUR	38	MERSEY	44	ALMERIA	139	MOURA	166
ARDAS	53	MIRANDE	115	ALVORADA	158	OBIDOS	174
ARDILA	66	MURES	76	AMBATO	131	OLINDA	162
ATRATO	103	NESTOS	12	ARUBA	188	PALMAS	186
AVON	36	NORMAN	102	ATICO	159	POSADAS	164
BARITO	100	OHIO	42	BARCELOS	131	PUELO	134
BELAJA	116	OLONA	112	BEJA	122	PUNO	129
BENI	55	PARANA	51	BILBAO	155	PURUS	143
BERMEJO	46	PEARL	30	BOLO	142	RAMOS	158
BLYDE	146	PEARL	31	BONITO	138	RICARDO	185
BREG	49	PIAVE	47	BRAGA	124	ROSARIO	127
BRENTA	102	RAVI	14	CACERES	143	SALTA	167
CAVADO	88	RENO	32	CAMARO	136	SCOOP	140
COLORADO	52	ROYA	56	CAMPUS	176	SILVES	154
COOPER	70	RUVUMA	98	CHAIN	191	SINTRA	135
CUANDO	42	SALMON	18	COBRE	157	STICK	140
DAWSON	29	SAMBESI	90	COLOMBO	150	SUAREZ	180
DUERO	114	TAGUS	20	CORDOBA	126	TALCA	171
ELBE	61	TANA	101	CUSCO	125	VIAMAO	162
ELVO	106	TANARO	113	DIADEMA	168		
FRASER	72	TAWA	39	DIAZ	184		
FUERTE	24	TAY	52	ELVAS	170		
GARONNE	95	THAMES	40	EMBER	190		
HOOSIC	78	THAMES II	41	ESQUEL	164		
HORTON	34	TIBER	53	FERNANDEZ	182		
HUDSON	86	TIMOK	48	FESTIVAL	175		
INDUS	48	TRENT	43	FOMOSA	167		
KANSAS	35	TRIOTO	64	FORTALEZA	130		
KASAI	44	TUMEN	100	FUNCHAL	132		
KAVERI	54	TURIA	50	GORDA	152		
KONDA	45	UBANGI	117	JAMAICA	189		
LIVENZA	108	VENTA	110	KENDAL	136		
LUNGA	114	VOLGA	62	LAGOAS	163		
MAAS	60	VOLTURNO	104	LENNON	183		
MACKENZIE	22	WITHAM	26	MACAPA	168		
MALAWI	148	YAMUNA	50	MELO	172		
MARIZA	16	YANGTZE	45	MOLINA	128		
MARNE	28			MOOD	176		

Produktübersicht · Product Overview

Aperçu des produits · Productoverzicht · Descripción del producto ·

Panoramica prodotto · Vizualizare produs · Tuotteen yleiskuvaus · Przegląd produktów



MURES
76



MACKENZIE
22



FRASER
72



MARIZA
16



DAWSON
29



MARNE
28



FUERTE
24



OHIO
42



BEJA
122



TRIOTO
64



WITHAM
26



PUELO
134



PEARL
30



KANSAS
35



RAVI
14



NESTOS
12



YANGTZE
45



CUANDO
42



HORTON
34



ELBE
61



MAAS
60



VOLGA
62



TURIA
50



YAMUNA
50



PARANA
51



THAMES
40



THAMES II
41



SALMON
18



TRENT
43



ADOUR
38



COLORADO
52



TAY
52



ARDAS
53



MAYENNE
43



RENO
32

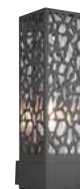

COOPER
70



AVON
36



ROYA
58



ROYA
56



TIBER
53



KAVERI
54



BENI
55



BRAGA
124



ADAJA
40



CORDOBA
126



ROSARIO
127



FUNCHAL
132



KANSAS
35



TAWA
39



CUSCO
125



BARCELOS
131



AMBATO
131



PUNO
129



FORTALEZA
130



TAGUS
20



HOOSIC
78



HOOSIC
84



MOLINA
128



MOLINA
128



SINTRA
135



MERSEY
44



KASAI
44



SALMON
18



ARDILA
68



ARDILA
66



ALMERIA
139



BONITO
138



GARONNE
95



GARONNE
96



VENTA
110



INDUS
48



TIMOK
48

Produktübersicht · Product Overview

Aperçu des produits · Productoverzicht · Descripción del producto ·

Panoramica prodotto · Vizualizare produs · Tuotteen yleiskuvaus · Przegląd produktów



KONDA
45



KENDAL
136



TUMEN
100



BREG
49



KENDAL
136



CAMARO
136



PIAVE
47



BERMEJO
46

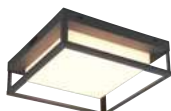

WITHAM
26



GARONNE
96



SAMBESI
90



TANARO
113



LUNGA
114



OLONA
112



CAVADO
88



RUVUMA
98



DUERO
114



NORMAN
102



ATRATO
103



BRENTA
102



TANA
101



MIRANDE
115



ELVO
106



VOLTURNO
104



LIVENZA
108



VENTA
110



VOLGA
62



RAVI
14



NESTOS
12



MARIZA
16



WITHAM
26



FUERTE
24

Sicherheit & Komfort / Sensorleuchten · Security & Comfort / Sensor Lights

Sécurité et confort / Lampes à détecteur · Veiligheid en comfort/sensorlampen · Seguridad & Comodidad / Luces del sensor ·

Sicurezza e confort / Lampade con sensore integrat · Siguranță & confort / Lumini senzor ·

Turvallisuus ja mukavuus/tunnistinvalaisimet · Bezpieczeństwo i komfort / światła z czujnikami



MURES
76



PEARL
31



ROYA
56



MACKENZIE
22



SALMON
18



KAVERI
54



BENI
55



FRASER
74



BEJA
122



RENO
32



COOPER
70



TAGUS
20



HOOSIC
78



HOOSIC
84



TRIOTO
64



ARDILA
66



ARDILA
68



GARONNE
95



RUVUMA
98



HUDSON
86



SAMBESI
90



CAVADO
88



ELVO
106



VOLTURNO
104



LIVENZA
108



VENTA
110



CAVADO
88



SAMBESI
90



ELVO
106



VOLTURNO
104



LIVENZA
108

Spots, Einbauleuchten & Zubehör · Spotlights, Recessed luminaires & Accessories

Spots, lumières encastrées et accessoires · Spots, inbouwlampen en toebehoren · Puntos de luz, lámparas integradas y accesorios · Faretto, lampade da incasso e sensori · Spoturi, lămpi încorporate & accesorii · Kohdevalaisimet, upotettavat valaisimet ja tarvikkeet · Spoty, światła wpuszczane i akcesoria



BELAJA
116



CACERES
143

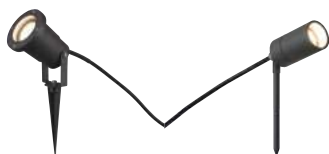

UBANGI
117



PURUS
143



BOLO
142



FESTIVAL
175



STICK
140



SCOOP
140



OBIDOS
174



STECKDOSEN
PLUG
118



STECKDOSEN
PLUG
118



ERDSPIESS
GROUND SPIKE
119



ECKHALTERUNG
CORNER FASTENING
119

Outdoor Living · Outdoor Living Lighting

Idées d'éclairage pour la vie en plein air · Lichtideeën voor buiten · Ideas de luz para la vida al aire libre · Idee di Illuminazione per l'Outdoor Living · Idei de iluminare pentru exterior · Outdoor Living -valaisinideat · Pomysły na oświetlenie zewnętrzne



ARUBA
188



JAMAICA
189



PALMAS
186



DIAZ
184



SUAREZ
180



RICARDO
185



LENNON
183



FERNANDEZ
182



MOOD
177



CHAIN
191



EMBER
190

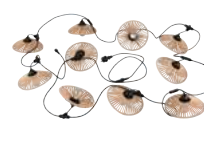

CHAIN
191

Solarleuchten · Solar Lights

Lampes solaires · Lampen op zonne-energie · Luces solares ·

Lampade solari · Lämpö solare · Aurinkovalaisimet · Światła z zasilaniem słonecznym



MALAWI
148



MALAWI
148



BLYDE
146



BLYDE
146



GORDA
152



GORDA
152



COLOMBO
150



COLOMBO
150



MORO
156



ATICO
159



RAMOS
158



COBRE
157



ELVAS
170



SILVES
154



BILBAO
155



FOMOSA
167



SALTA
167



LAGOAS
163



TALCA
171



OLINDA
162



POSADAS
164



ESQUEL
164



POSADAS
164



ESQUEL
164



MACAPA
168



ALVORADA
158



MOURA
166



VIAMAO
162



DIADEMA
168



ACORA
169



MELO
172



CAMPUS
176



MOOD
176



MOOD
177

NESTOS

Aluminium Druckguss, Kunststoff · Diecast aluminium, plastic ·
 Fonte d'aluminium, plastique · Gegoten aluminium, kunststof ·
 Aluminio fundido, plástico · Pressofusione di alluminio, plastica ·
 Fonta aluminiu, plastic · Valualumiini, muovii · Barwione aluminium, plastik



Bewegungssensor ·
 Motion sensor



42 | Anthrazit · anthracite



Wandleuchte · Wall lamp
 incl. SMD-LED
 13 W / 1.300 Lumen
 3.000 Kelvin
240960142

Wandleuchte · Wall lamp
 incl. SMD-LED
 13 W / 1.300 Lumen
 3.000 Kelvin
240969142

Sockelleuchte · Podestal lamp
 incl. SMD-LED
 13 W / 1.300 Lumen
 3.000 Kelvin
540969142

Bodenleuchte · Floor lamp
 incl. SMD-LED
 13 W / 1.300 Lumen
 3.000 Kelvin
440969142

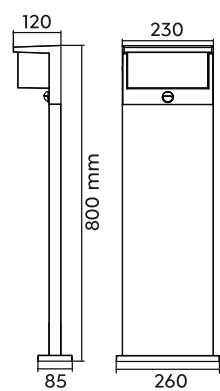
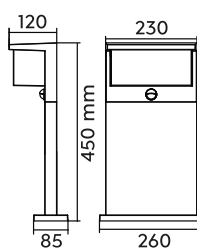
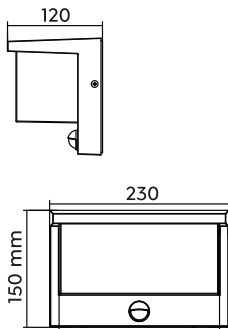
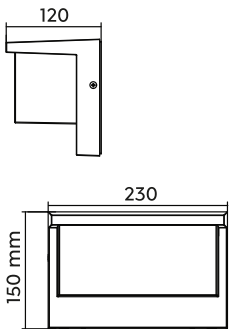



Aluminium Druckguss · Diecast aluminium ·
 Fonte d'aluminium · Gegoten aluminium · Aluminio fundido ·
 Pressofusione di alluminio · Fonta aluminiu ·
 Valualumiini · Barwione aluminium

 **42** | Anthrazit · anthracite



Bewegungssensor Multi-Control ·
 Multi-Control motion sensor



Bewegungssensor und Orientierungslicht ·
 Motion sensor and orientation light

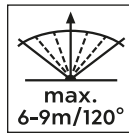

Wandleuchte · Wall lamp
 incl. SMD-LED
 13 W / 1.500 Lumen
 2.200 + 3.000 + 4.000 Kelvin
238660142

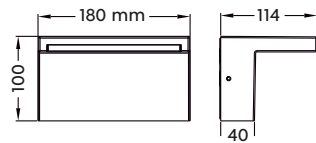

Wandleuchte · Wall lamp
 incl. SMD-LED
 13 W / 1.500 Lumen
 2.200 + 3.000 + 4.000 Kelvin
238669142

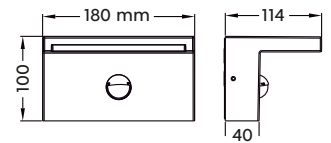

Sockelleuchte · Podestal lamp
 incl. SMD-LED
 13 W / 1.500 Lumen
 2.200 + 3.000 + 4.000 Kelvin
538660142

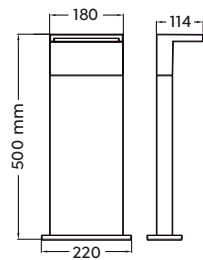

Sockelleuchte · Podestal lamp
 incl. SMD-LED
 13 W / 1.500 Lumen
 2.200 + 3.000 + 4.000 Kelvin
538669142

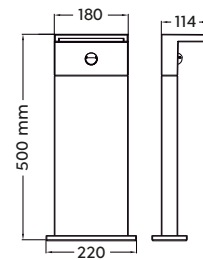

Bodenleuchte · Floor lamp
 incl. SMD-LED
 13 W / 1.500 Lumen
 2.200 + 3.000 + 4.000 Kelvin
438660142

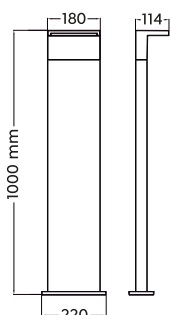

Bodenleuchte · Floor lamp
 incl. SMD-LED
 13 W / 1.500 Lumen
 2.200 + 3.000 + 4.000 Kelvin
438669142

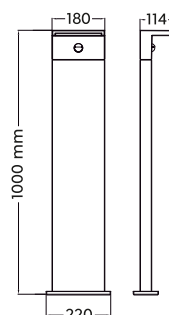



Lichtfarben direkt an der Leuchte einstellbar
Colours directly adjustable at the lamp



Helligkeit einstellbar
Adjustable light level



2.200 K



3.000 K



4.000 K

MARIZA

Aluminium Druckguss, Glas · Diecast aluminium, glass ·
 Fonte d'aluminium, verre · Gegoten aluminium, glas ·
 Aluminio fundido, vidrio · Pressofusione di alluminio, vetro ·
 Fonta aluminium, sticla · Valualumiini, lasi · Barwione aluminium, szkło

42 | Anthrazit · anthracite



Wandleuchte · Wall lamp
 incl. SMD-LED
 10 W / 1.100 Lumen
 3.000 Kelvin
247060142

IP65

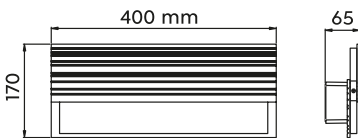

Sockelleuchte · Podestal lamp
 incl. SMD-LED
 11 W / 1.150 Lumen
 3.000 Kelvin
547060142

IP65

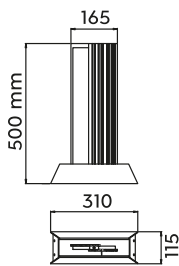

Bodenleuchte · Floor lamp
 incl. SMD-LED
 16 W / 1.800 Lumen
 3.000 Kelvin
447060142

IP65

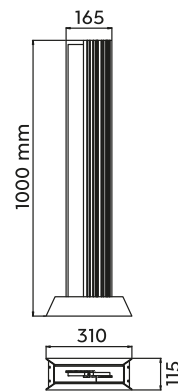

MARIZA

Aluminium Druckguss, Glas · Diecast aluminium, glass ·
Fonte d'aluminium, verre · Gegoten aluminium, glas ·
Aluminio fundido, vidrio · Pressofusione di alluminio, vetro ·
Fonta aluminiu, sticla · Valualumiini, lasi · Barwione aluminium, szkło



Bewegungssensor ·
Motion sensor

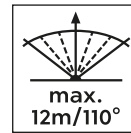

42 | Anthrazit · anthracite



Wandleuchte · Wall lamp

incl. SMD-LED
10 W / 1.100 Lumen
3.000 Kelvin
247069142



IP44

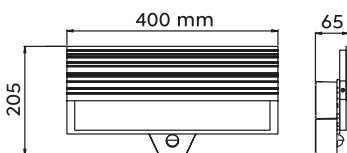

SALMON

Aluminium Druckguss, Holznachbildung · Diecast aluminium, wood imitation ·
 Fonte d'aluminium, imitation bois · Gegoten aluminium, houtimitatie ·
 Aluminio fundido, imitación de madera · Pressofusione di alluminio, effetto legno ·
 Fonta aluminiu, imitație de lemn · Valualumiini, puujäljitelmä ·
 Barwione aluminium, imitacja drewna



Bewegungssensor ·
 Motion sensor

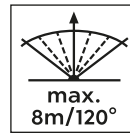

35 | Holznachbildung / Anthrazit · wood imitation / anthracite



Wandleuchte · Wall lamp
 incl. SMD-LED
 11 W / 1.200 Lumen
 3.000 Kelvin
246969135

Wandleuchte · Wall lamp
 incl. SMD-LED
 11 W / 1.200 Lumen
 3.000 Kelvin
246960135

Sockelleuchte · Podestal lamp
 incl. SMD-LED
 11 W / 1.200 Lumen
 3.000 Kelvin
546960135

Bodenleuchte · Floor lamp
 incl. SMD-LED
 11 W / 1.200 Lumen
 3.000 Kelvin
446960135

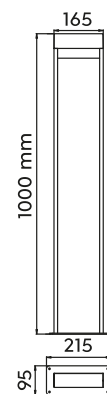
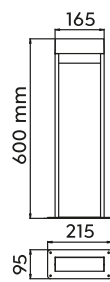
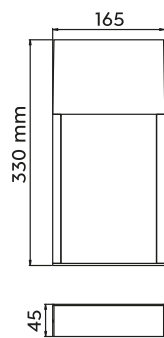
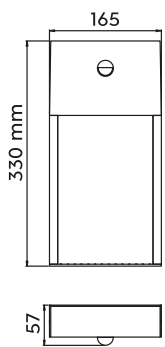



Aluminium Druckguss · Diecast aluminium ·
 Fonte d'aluminium · Gegoten aluminium · Aluminio fundido ·
 Pressofusione di alluminio · Fonta aluminii ·
 Valualumiini · Barwione aluminium

 **42** | Anthrazit · anthracite



Bewegungssensor Multi-Control ·
 Multi-Control motion sensor



Bewegungssensor und Orientierungslicht ·
 Motion sensor and orientation light



Wandleuchte · Wall lamp
 incl. SMD-LED
 13 W / 1.500 Lumen
 2.200 + 3.000 + 4.000 Kelvin
238560142

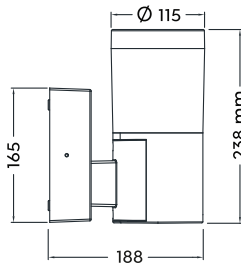

Wandleuchte · Wall lamp
 incl. SMD-LED
 13 W / 1.500 Lumen
 2.200 + 3.000 + 4.000 Kelvin
238569142

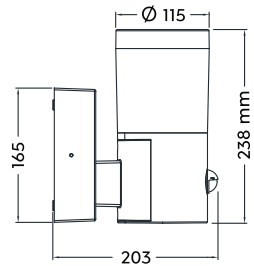

Sockelleuchte · Podestal lamp
 incl. SMD-LED
 13 W / 1.500 Lumen
 2.200 + 3.000 + 4.000 Kelvin
538560142



Sockelleuchte · Podestal lamp
 incl. SMD-LED
 13 W / 1.500 Lumen
 2.200 + 3.000 + 4.000 Kelvin
538569142



Bodenleuchte · Floor lamp
 incl. SMD-LED
 13 W / 1.500 Lumen
 2.200 + 3.000 + 4.000 Kelvin
438560142



Bodenleuchte · Floor lamp
 incl. SMD-LED
 13 W / 1.500 Lumen
 2.200 + 3.000 + 4.000 Kelvin
438569142





Lichtfarben direkt an der Leuchte einstellbar
Colours directly adjustable at the lamp



Helligkeit einstellbar
Adjustable light level



2.200 K



3.000 K



4.000 K

MACKENZIE

Aluminium Druckguss, Kunststoff · Diecast aluminium, plastic ·
Fonte d'aluminium, plastique · Gegoten aluminium, kunststof ·
Aluminio fundido, plástico · Pressofusione di alluminio, plastica ·
Fonta aluminiu, plastic · Valualumiini, muovi · Barwione aluminium, plastik

42 | Anthrazit · anthracite



Wandleuchte · Wall lamp
incl. SMD-LED
8 W / 800 Lumen
3.000 Kelvin
230561142

IP54

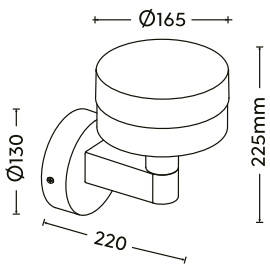

Sockelleuchte · Podestal lamp
incl. SMD-LED
8 W / 800 Lumen
3.000 Kelvin
530561142

IP54

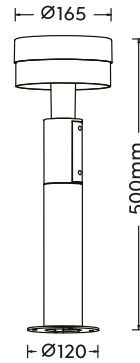

Bodenleuchte · Floor lamp
incl. SMD-LED
8 W / 800 Lumen
3.000 Kelvin
430561142

IP54

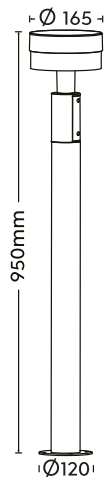

MACKENZIE

Aluminium Druckguss, Kunststoff · Diecast aluminium, plastic ·
Fonte d'aluminium, plastique · Gegoten aluminium, kunststof ·
Aluminio fundido, plástico · Pressofusione di alluminio, plastica ·
Fonta aluminiu, plastic · Valualumiini, muovii · Barwione aluminium, plastik



Bewegungssensor ·
Motion sensor

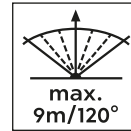

42 | Anthrazit · anthracite



Wandleuchte · Wall lamp
incl. SMD-LED
8 W / 800 Lumen
3.000 Kelvin
230569142



IP54

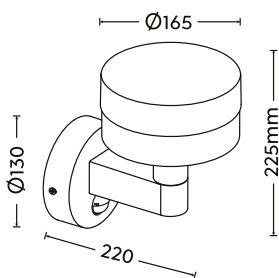

FUERTE

Aluminium Druckguss, Acryl · Diecast aluminium, acryl ·
 Fonte d'aluminium, acryl · Gegoten aluminium, acryl ·
 Aluminio fundido, acrílico · Pressofusione di alluminio, acrilico ·
 Fonta aluminiu, acrilic · Valualumiini, akryyli · Barwione aluminium, akryl

42 | Anthrazit · anthracite

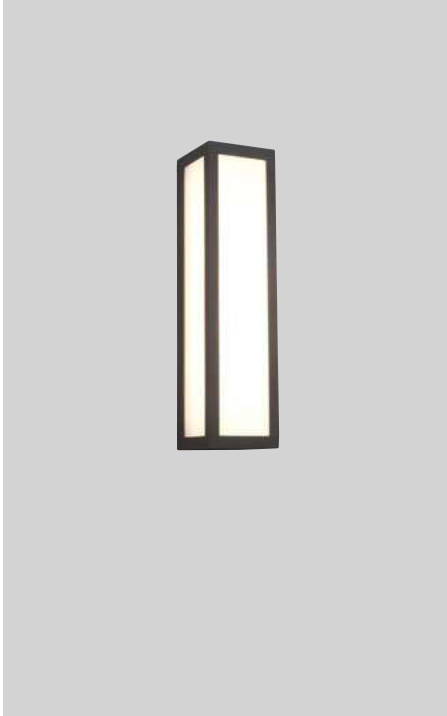

Wandleuchte · Wall lamp
 incl. SMD-LED
 10,5 W / 1.300 Lumen
 3.000 Kelvin
 2262601**42**

IP54

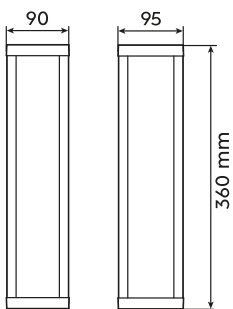

Sockelleuchte · Podestal lamp
 incl. SMD-LED
 15 W / 1.700 Lumen
 3.000 Kelvin
 5262601**42**

IP54

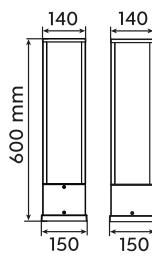

Bodenleuchte · Floor lamp
 incl. SMD-LED
 15 W / 1.700 Lumen
 3.000 Kelvin
 4262601**42**

IP54

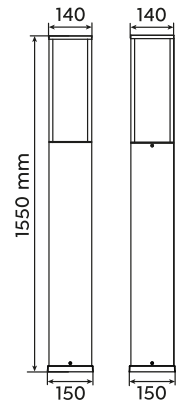





42 | Anthrazit · anthracite



Wandleuchte · Wall lamp
 incl. SMD-LED
 10,5 W / 1.100 Lumen
 2.300 + 3.000 + 4.000 Kelvin
277860142

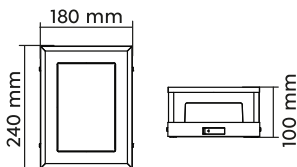

Deckenleuchte · Ceiling lamp
 incl. SMD-LED
 14 W / 1.550 Lumen
 2.300 + 3.000 + 4.000 Kelvin
677860142

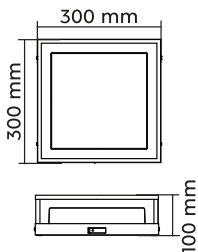

Sockelleuchte · Podestal lamp
 incl. SMD-LED
 14,5 W / 1.450 Lumen
 2.300 + 3.000 + 4.000 Kelvin
577860142

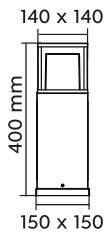

Bodenleuchte · Floor lamp
 incl. SMD-LED
 14,5 W / 1.450 Lumen
 2.300 + 3.000 + 4.000 Kelvin
477860142

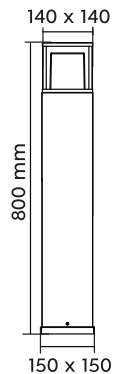



MARNE

Aluminium Druckguss, Acryl · Diecast aluminium, acryl ·
Fonte d'aluminium, acryl · Gegoten aluminium, acryl ·
Aluminio fundido, acrílico · Pressofusione di alluminio, acrilico ·
Fonta aluminiu, acrilic · Valualumiini, akryyli · Barwione aluminium, akryl

● 42 | Anthrazit · anthracite

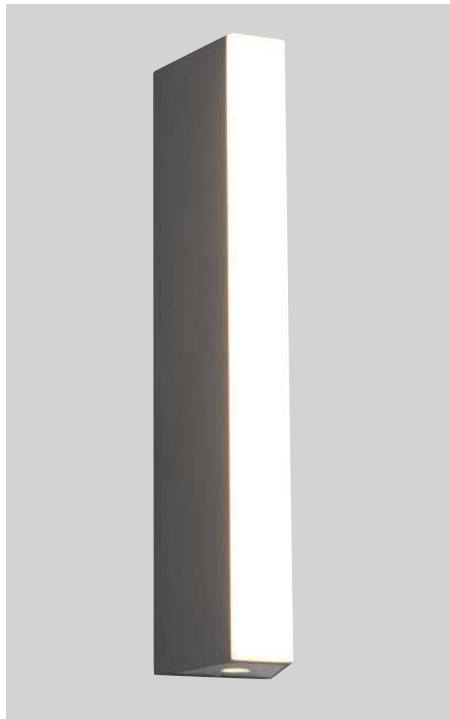

Wandleuchte · Wall lamp
incl. SMD-LED
8,5 W / 1.000 Lumen
3.000 Kelvin
247360242

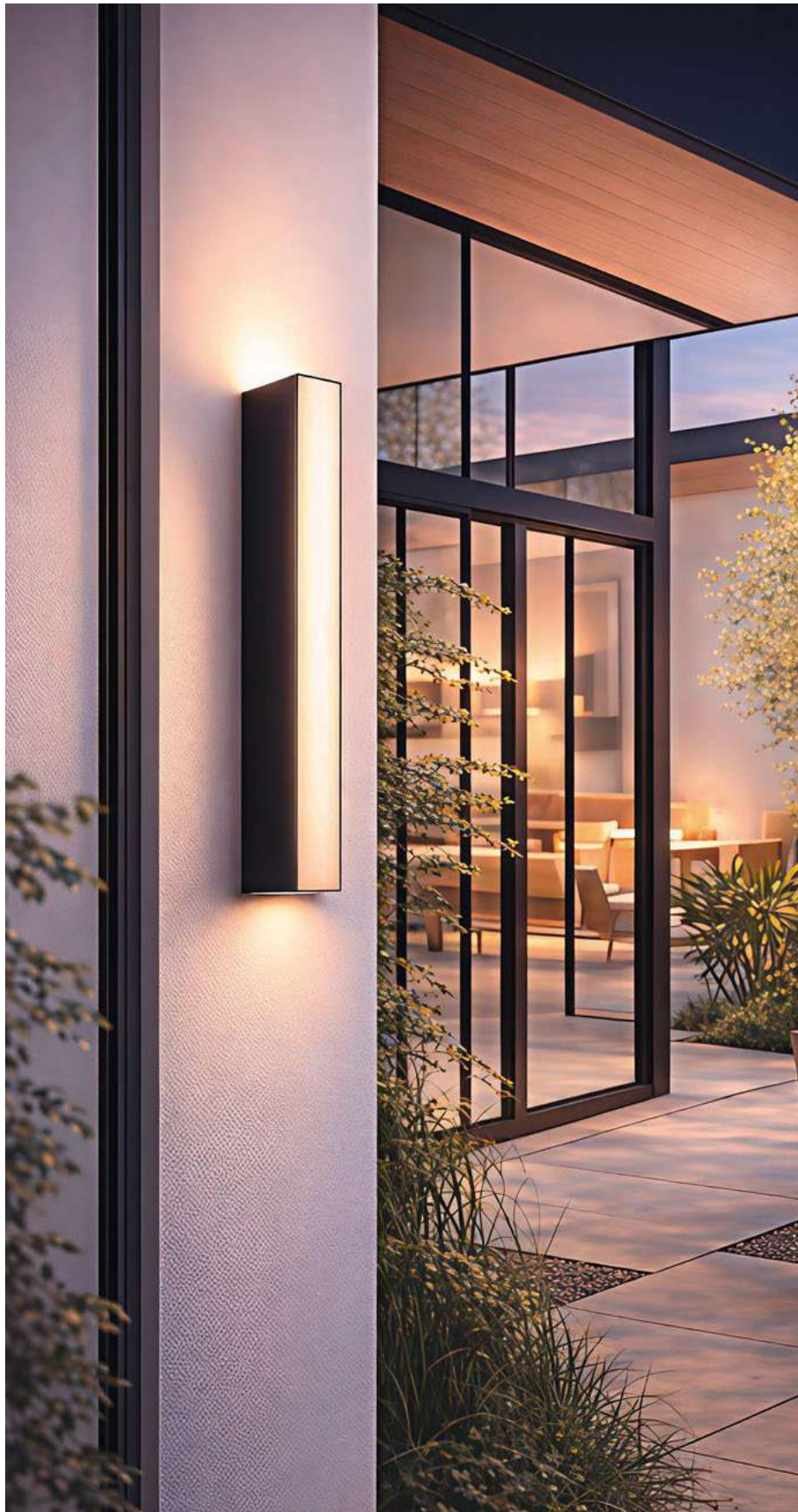
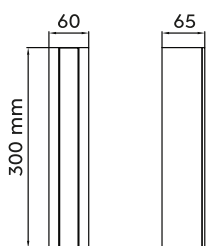

DAWSON

Aluminium Druckguss, Acryl · Diecast aluminium, acryl ·
 Fonte d'aluminium, acryl · Gegoten aluminium, acryl ·
 Aluminio fundido, acrílico · Pressofusione di alluminio, acrilico ·
 Fonta aluminiu, acrilic · Valualumiini, akryyli · Barwione aluminium, akryl



Lichtfarben direkt an der Leuchte einstellbar
 Colours directly adjustable at the lamp

● 42 | Anthrazit · anthracite



Wandleuchte · Wall lamp
 incl. SMD-LED
 7 W / 800 Lumen
 2.300 + 3.000 + 4.000 Kelvin
246360142

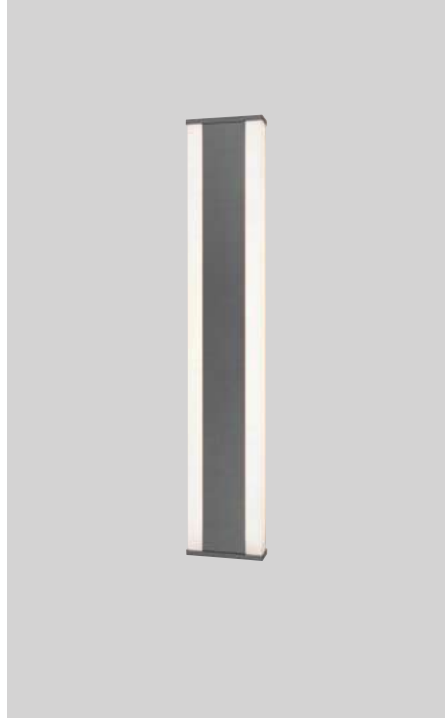
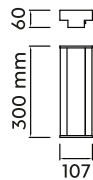

Wandleuchte · Wall lamp
 incl. SMD-LED
 8 W / 900 Lumen
 2.300 + 3.000 + 4.000 Kelvin
246360242

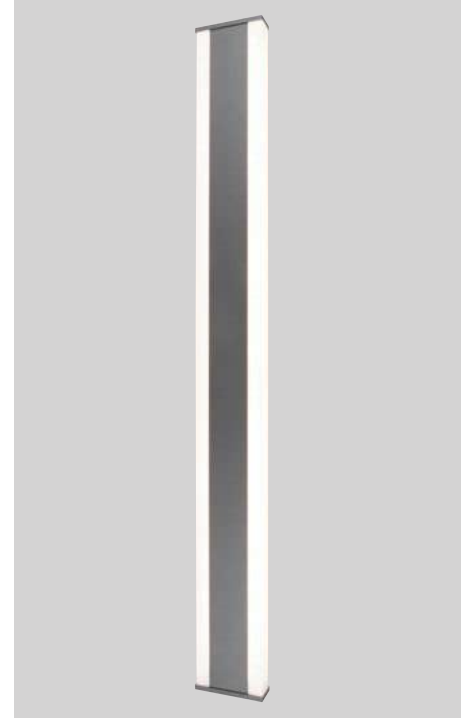

Wandleuchte · Wall lamp
 incl. SMD-LED
 11 W / 1.300 Lumen
 2.300 + 3.000 + 4.000 Kelvin
246360342

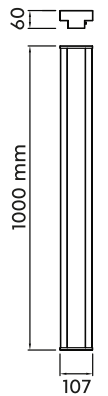

PEARL

Aluminium Druckguss, Kunststoff · Diecast aluminium, plastic ·
 Fonte d'aluminium, plastique · Gegoten aluminium, kunststof ·
 Aluminio fundido, plástico · Pressofusione di alluminio, plastica ·
 Fonta aluminiu, plastic · Valualumiini, muovi · Barwione aluminium, plastik

42 | Anthrazit · anthracite



Wandleuchte · Wall lamp
 incl. SMD-LED
 8 W / 900 Lumen
 3.000 Kelvin
221160142

⊕ IP54

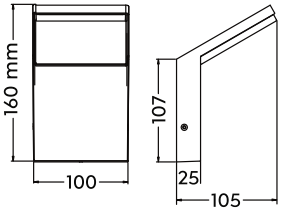

Sockelleuchte · Podestal lamp
 incl. SMD-LED
 8 W / 900 Lumen
 3.000 Kelvin
521160142

⊕ IP54

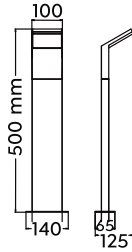

Bodenleuchte · Floor lamp
 incl. SMD-LED
 8 W / 900 Lumen
 3.000 Kelvin
421160142

⊕ IP54

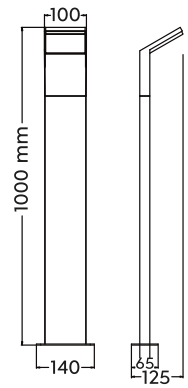

PEARL

Aluminium Druckguss, Kunststoff · Diecast aluminium, plastic ·
 Fonte d'aluminium, plastique · Gegoten aluminium, kunststof ·
 Aluminio fundido, plástico · Pressofusione di alluminio, plastica ·
 Fonta aluminiu, plastic · Valualumiini, muovi · Barwione aluminium, plastik



Bewegungssensor ·
 Motion sensor

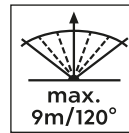

42 | Anthrazit · anthracite



Wandleuchte · Wall lamp
 incl. SMD-LED
 8 W / 900 Lumen
 3.000 Kelvin
221169142

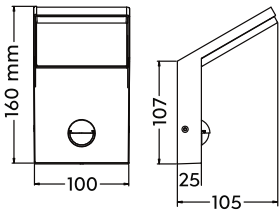

Sockelleuchte · Podestal lamp
 incl. SMD-LED
 8 W / 900 Lumen
 3.000 Kelvin
521169142

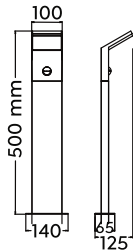

Bodenleuchte · Floor lamp
 incl. SMD-LED
 8 W / 900 Lumen
 3.000 Kelvin
421169142

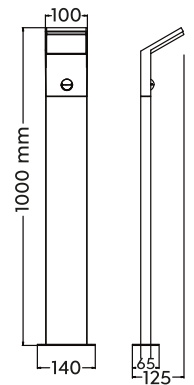

RENO

Aluminium Druckguss · Diecast aluminium ·
 Fonte d'aluminium · Gegoten aluminium · Aluminio fundido
 Pressofusione di alluminio · Fonta aluminiu · Valualumiini · Barwione aluminium

42 | Anthrazit · anthracite



Wandleuchte · Wall lamp
 incl. COB-LED
 4,5 W / 450 Lumen
 3.000 Kelvin
220760142

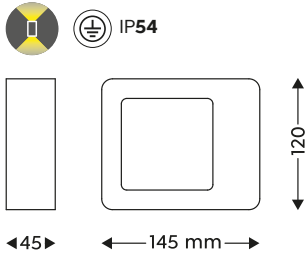

Sockelleuchte · Podestal lamp
 incl. COB-LED
 4,5 W / 450 Lumen
 3.000 Kelvin
520760142

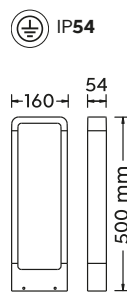

Bodenleuchte · Floor lamp
 incl. COB-LED
 4,5 W / 450 Lumen
 3.000 Kelvin
420760142

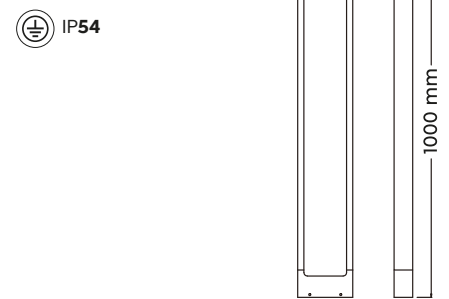



HORTON

Aluminium Druckguss · Diecast aluminium ·
 Fonte d'aluminium · Gegoten aluminium · Aluminio fundido
 Pressofusione di alluminio · Fonta aluminii · Valualumiini · Barwione aluminium



Bewegungssensor ·
 Motion sensor

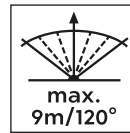

42 | Anthrazit · anthracite



Wandleuchte · Wall lamp
 incl. SMD-LED
 8 W / 1.000 Lumen
 3.000 Kelvin
226360142

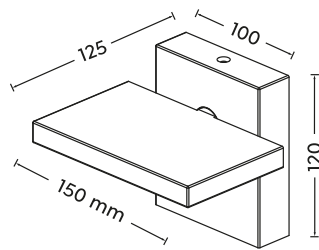

Wandleuchte · Wall lamp
 incl. SMD-LED
 8 W / 1.000 Lumen
 3.000 Kelvin
226369142

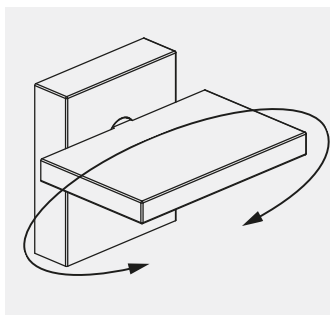
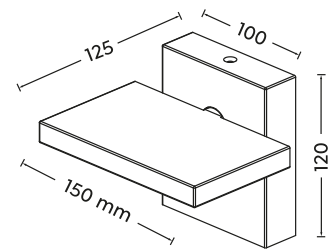

KANSAS

Aluminium Druckguss, Acryl · Diecast aluminium, acryl ·
 Fonte d'aluminium, acryl · Gegoten aluminium, acryl ·
 Aluminio fundido, acrílico · Pressofusione di alluminio, acrilico ·
 Fonta aluminiu, acrilic · Valualumiini, akryyli · Barwione aluminium, akryl



Bewegungssensor ·
 Motion sensor

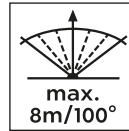

42 | Anthrazit · anthracite



Wandleuchte · Wall lamp
 incl. SMD-LED
 10 W / 1.000 Lumen
 3.000 Kelvin
246860142

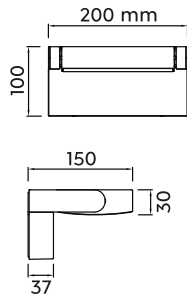

Wandleuchte · Wall lamp
 incl. SMD-LED
 10 W / 1.000 Lumen
 3.000 Kelvin
246869142

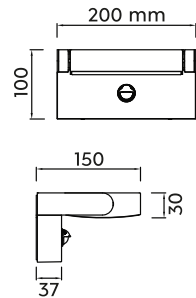

AVON

Aluminium Druckguss, Acryl · Diecast aluminium, acryl ·
Fonte d'aluminium, acryl · Gegoten aluminium, acryl ·
Aluminio fundido, acrílico · Pressofusione di alluminio, acrilico ·
Fonta aluminiu, acrilic · Valualumiini, akryyli · Barwione aluminium, akryl



42 | Anthrazit · anthracite



Wandleuchte · Wall lamp
incl. SMD-LED
7 W / 800 Lumen
3.000 Kelvin
270660142

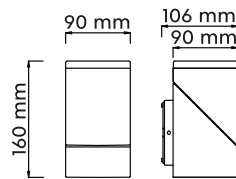

Wandleuchte · Wall lamp
incl. 2 x SMD-LED
2 x 7 W / 2 x 800 Lumen
3.000 Kelvin
270660242

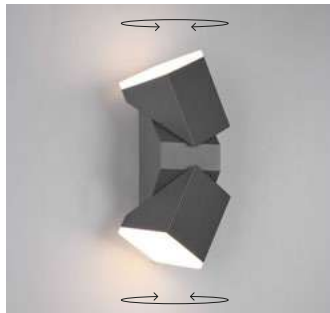
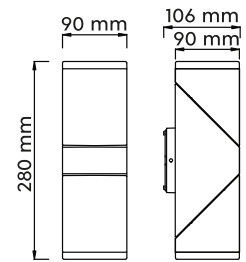

AVON

Aluminium Druckguss, Acryl · Diecast aluminium, acryl ·
 Fonte d'aluminium, acryl · Gegoten aluminium, acryl ·
 Aluminio fundido, acrílico · Pressofusione di alluminio, acrilico ·
 Fonta aluminiu, acrilic · Valualumiini, akryyli · Barwione aluminium, akryl

● 42 | Anthrazit · anthracite



Bewegungssensor ·
 Motion sensor



Bewegungssensor und Orientierungslicht ·
 Motion sensor and orientation light

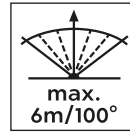

Wandleuchte · Wall lamp
 incl. SMD-LED
 7 W / 800 Lumen
 3.000 Kelvin
270660142

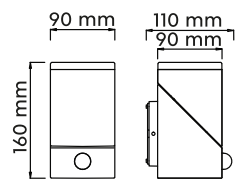

Wandleuchte · Wall lamp
 incl. 2 x SMD-LED
 2 x 7 W / 2 x 800 Lumen
 3.000 Kelvin
270660242

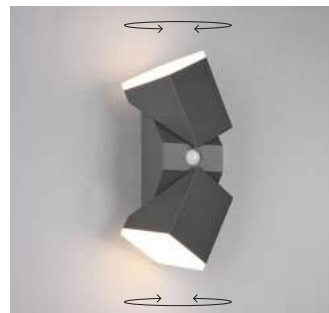
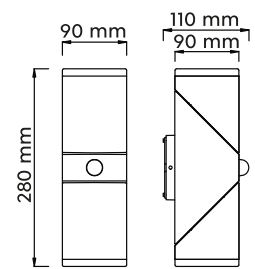

ADOUR

Aluminium Druckguss, Acryl · Diecast aluminium, acryl ·
 Fonte d'aluminium, acryl · Gegoten aluminium, acryl ·
 Aluminio fundido, acrílico · Pressofusione di alluminio, acrilico ·
 Fonta aluminiu, acrilic · Valualumiini, akryyli · Barwione aluminium, akryl

 DIP SWITCH

 Kippbar ·
Tilttable

 Bewegungssensor ·
Motion sensor

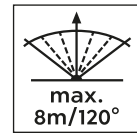

 42 | Anthrazit · anthracite



Wandleuchte · Wall lamp
 incl. SMD-LED
 7,5 W / 750 Lumen
 2.300 + 3.000 + 4.000 Kelvin
245560142

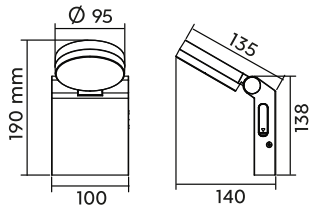

Wandleuchte · Wall lamp
 incl. SMD-LED
 7,5 W / 750 Lumen
 2.300 + 3.000 + 4.000 Kelvin
245569142

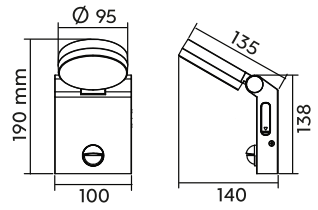

Aluminium Druckguss · Diecast aluminium ·
 Fonte d'aluminium · Gegoten aluminium · Aluminio fundido
 Pressofusione di alluminio · Fonta aluminiu · Valualumiini · Barwione aluminium

● 42 | Anthrazit · anthracite

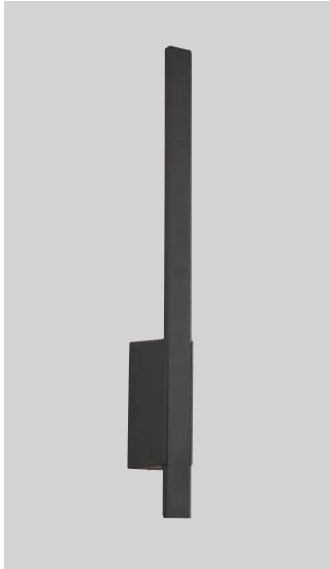

Wandleuchte · Wall lamp
 incl. SMD-LED
 7,5 W / 800 Lumen
 3.000 Kelvin
221460142

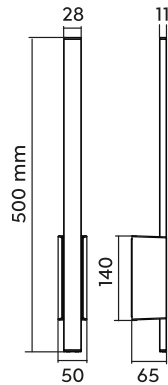

Wandleuchte · Wall lamp
 incl. 2 x SMD-LED
 2 x 9 W / 2 x 900 Lumen
 3.000 Kelvin
221460242

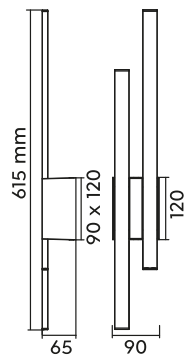

ADAJA

Aluminium Druckguss · Diecast aluminium ·
Fonte d'aluminium · Gegoten aluminium · Aluminio fundido
Pressofusione di alluminio · Fonta aluminii · Valualumiini ·
Barwione aluminium

42 | Anthrazit · anthracite



Wandleuchte · Wall lamp
incl. 2 x SMD-LED
2 x 3 W / 2 x 350 Lumen
3.000 Kelvin
226860242

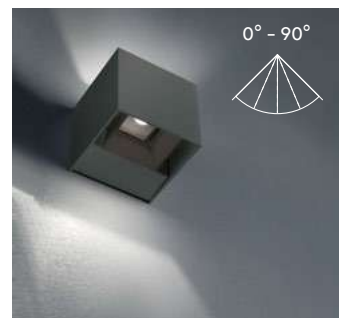
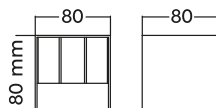

THAMES

Aluminium Druckguss · Diecast aluminium ·
Fonte d'aluminium · Gegoten aluminium · Aluminio fundido
Pressofusione di alluminio · Fonta aluminii · Valualumiini ·
Barwione aluminium

42 | Anthrazit · anthracite



Wandleuchte · Wall lamp
incl. 2 x SMD-LED
2 x 3 W / 2 x 340 Lumen
3.000 Kelvin
229360242

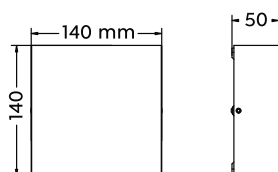

THAMES II

Aluminium Druckguss · Diecast aluminium ·
 Fonte d'aluminium · Gegoten aluminium · Aluminio fundido
 Pressofusione di alluminio · Fonta aluminiu · Valualumiini · Barwione aluminium

 **31** | Weiß matt · white mat

 **42** | Anthrazit · anthracite



Wandleuchte · Wall lamp
 incl. 2 x SMD-LED
 2 x 2,5 W / 2 x 260 Lumen
 3.000 Kelvin
227560231
227560242

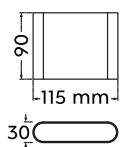

42



Wandleuchte · Wall lamp
 incl. 2 x SMD-LED
 2 x 4,5 W / 2 x 450 Lumen
 3.000 Kelvin
227660231
227660242

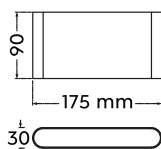

42

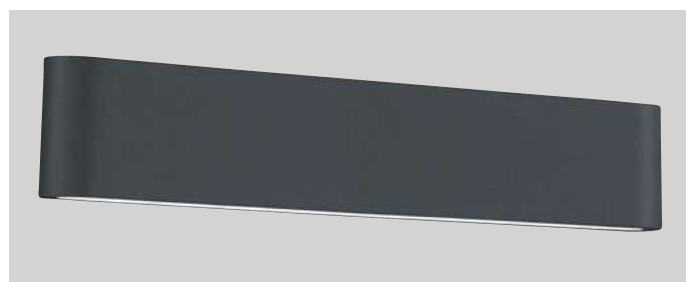

Wandleuchte · Wall lamp
 incl. 2 x SMD-LED
 2 x 8 W / 2 x 800 Lumen
 3.000 Kelvin
226460242

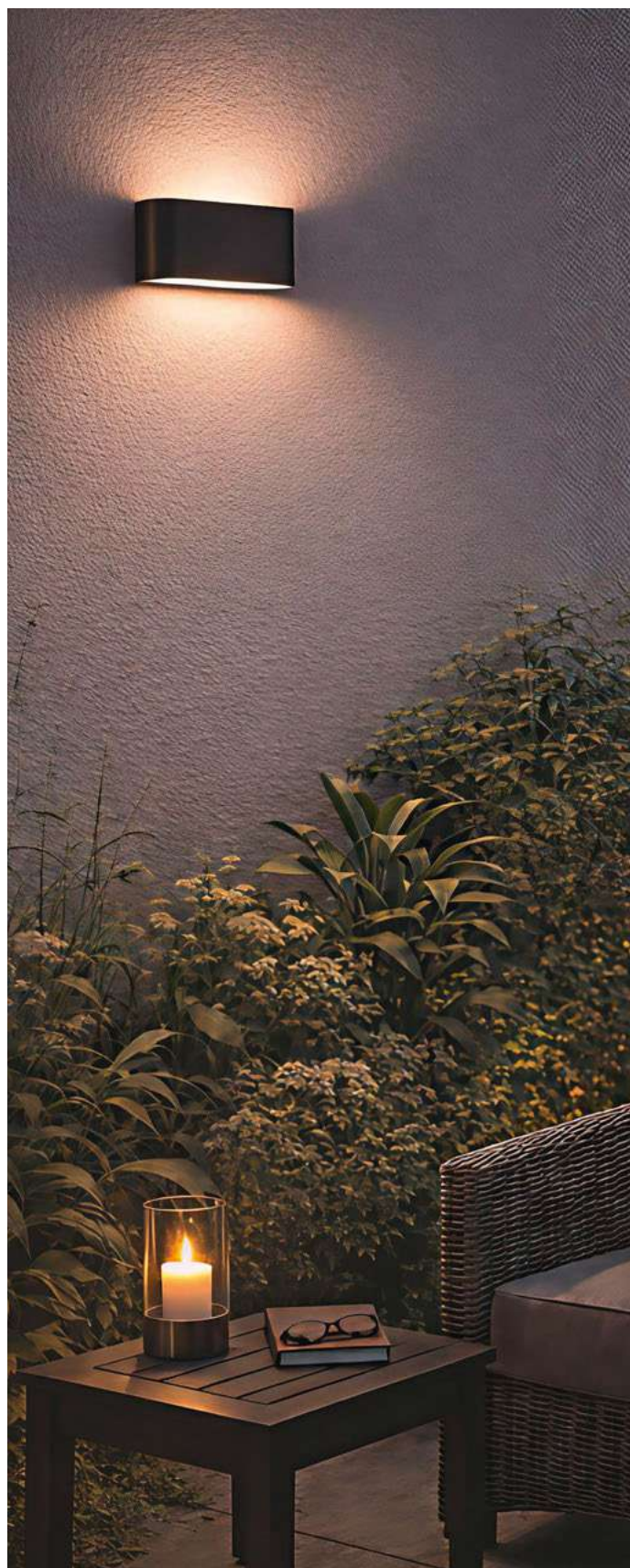
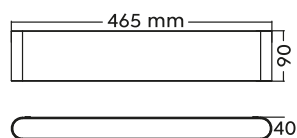

CUANDO

Aluminium Druckguss, Acryl · Diecast aluminium, acryl ·
 Fonte d'aluminium, acryl · Gegoten aluminium, acryl ·
 Aluminio fundido, acrílico · Pressofusione di alluminio, acrilico ·
 Fonta aluminiu, acrilic · Valualumiini, akryyli · Barwione aluminium, akryl

42 | Anthrazit · anthracite

 Bewegungssensor ·
 Motion sensor

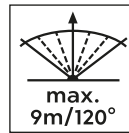

Wandleuchte · Wall lamp
 incl. SMD-LED
 11 W / 1.400 Lumen
 3.000 Kelvin
226660242

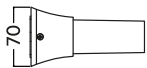
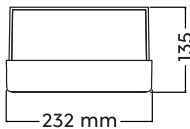

Wandleuchte · Wall lamp
 incl. SMD-LED
 11 W / 1.400 Lumen
 3.000 Kelvin
226669242

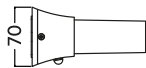
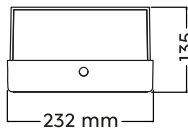

OHIO

Aluminium Druckguss, Kunststoff · Diecast aluminium, plastic ·
 Fonte d'aluminium, plastique · Gegoten aluminium, kunststof ·
 Aluminio fundido, plástico · Pressofusione di alluminio, plastica ·
 Fonta aluminiu, plastic · Valualumiini, muov · Barwione aluminium, plastik

42 | Anthrazit · anthracite

 Bewegungssensor ·
 Motion sensor

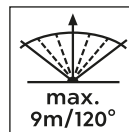

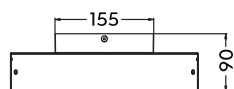
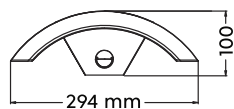

Wandleuchte · Wall lamp
 incl. SMD-LED
 7,5 W / 800 Lumen
 3.000 Kelvin
220969142



TRENT

Aluminium Druckguss · Diecast aluminium ·
 Fonte d'aluminium · Gegoten aluminium · Aluminio fundido
 Pressofusione di alluminio · Fonta aluminiu · Valualumiini · Barwione aluminium

-  **31** | Weiß matt · white mat
-  **42** | Anthrazit · anthracite



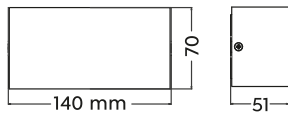

Wandleuchte · Wall lamp
 incl. SMD-LED
 9 W / 1.100 Lumen
 3.000 Kelvin
226960231
226960242



MAYENNE

Aluminium Druckguss, Acryl · Diecast aluminium, acryl ·
 Fonte d'aluminium, acryl · Gegoten aluminium, acryl ·
 Aluminio fundido, acrílico · Pressofusione di alluminio, acrilico ·
 Fonta aluminiu, acrilic · Valualumiini, akryyli · Barwione aluminium, akryl

-  **31** | Weiß matt · white mat
-  **35** | Holznachbildung · wood imitation
-  **42** | Anthrazit · anthracite



Wandleuchte · Wall lamp
 excl. 2 x E14
 max. 10 W
218560231
218560235
218560242

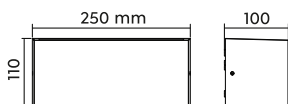

Empfohlen:
 recommended:

Filament LED
 E14, 4 W
 470 lm, 2.700 K



989-400



MERSEY

Aluminium Druckguss, Kunststoff · Diecast aluminium, plastic ·
Fonte d'aluminium, plastique · Gegoten aluminium, kunststof ·
Aluminio fundido, plástico · Pressofusione di alluminio, plastica ·
Fonta aluminiu, plastic · Valualumiini, muov · Barwione aluminium, plastik



Inkl. Hausnummern-Set ·
Incl. set of house numbers



Dämmerungssensor ·
Dusk sensor

42 | Anthrazit · anthracite



Wandleuchte · Wall lamp
excl. 2 x E14
max. 40 W
212160242

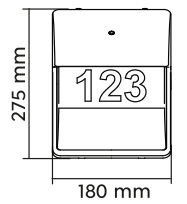

KASAI

Aluminium Druckguss, Kunststoff · Diecast aluminium, plastic ·
Fonte d'aluminium, plastique · Gegoten aluminium, kunststof ·
Aluminio fundido, plástico · Pressofusione di alluminio, plastica ·
Fonta aluminiu, plastic · Valualumiini, muov · Barwione aluminium, plastik



Inkl. Hausnummern-Set ·
Incl. set of house numbers



Dämmerungssensor ·
Dusk sensor

42 | Anthrazit · anthracite



Wandleuchte · Wall lamp
incl. SMD-LED
9 W / 850 Lumen
3.000 Kelvin
228669142

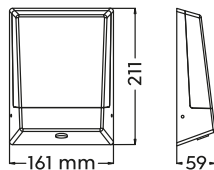

KONDA

Aluminium Druckguss, Kunststoff · Diecast aluminium, plastic ·
Fonte d'aluminium, plastique · Gegoten aluminium, kunststof ·
Aluminio fundido, plástico · Pressofusione di alluminio, plastica ·
Fonta aluminiu, plastic · Valualumiini, muovi · Barwione aluminium, plastik

42 | Anthrazit · anthracite



Wandleuchte · Wall lamp
incl. SMD-LED
9 W / 1.200 Lumen
3.000 Kelvin
228560242

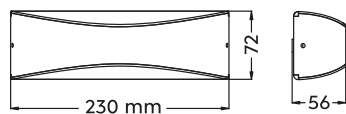

YANGTZE

Aluminium Druckguss, Kunststoff · Diecast aluminium, plastic ·
Fonte d'aluminium, plastique · Gegoten aluminium, kunststof ·
Aluminio fundido, plástico · Pressofusione di alluminio, plastica ·
Fonta aluminiu, plastic · Valualumiini, muovi · Barwione aluminium, plastik

42 | Anthrazit · anthracite



Wandleuchte · Wall lamp
incl. SMD-LED
4,5 W / 400 Lumen
3.000 Kelvin
228260142

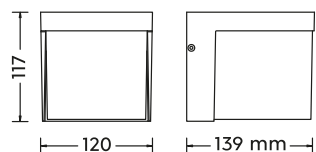

BERMEJO

Metall, Kunststoff · Metal, plastic ·
 Metale, plastique · Metaal, kunststof · Metal, plástico
 Metallo, plastica · Metal, plastic · Metalli, muovi · Metal, plastik

● 42 | Anthrazit · anthracite

 Bewegungssensor ·
 Motion sensor

 DIP SWITCH



 Inkl. Hausnummern-Set ·
 Incl. set of house numbers



Wandleuchte · Wall lamp
 incl. SMD-LED
 14 W / 1.450 Lumen
 2.300 + 3.000 + 4.000 Kelvin
630369142

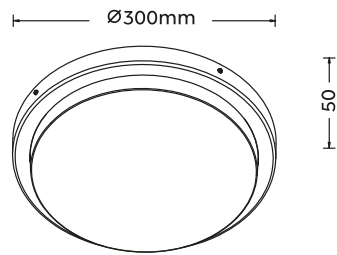

Wandleuchte · Wall lamp
 incl. SMD-LED
 14 W / 1.450 Lumen
 2.300 + 3.000 + 4.000 Kelvin
630369242

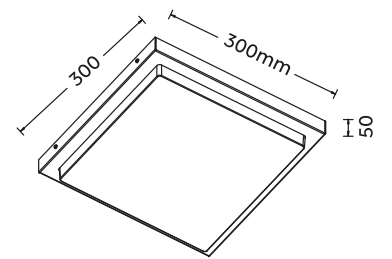

PIAVE

Kunststoff · Plastic ·
Plastique · Kunststoff · Plástico
Plastica · Plastic · Muovi · Plastik

● 42 | Anthrazit · anthracite



Bewegungssensor ·
Motion sensor

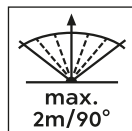

Wandleuchte · Wall lamp
incl. SMD-LED
11 W / 1.180 Lumen
3.000 Kelvin
676960142



IP54

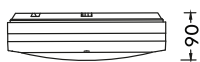
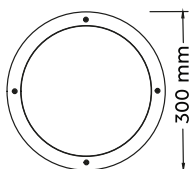

TIMOK

Aluminium Druckguss, Kunststoff · Diecast aluminium, plastic ·
Fonte d'aluminium, plastique · Gegoten aluminium, kunststof ·
Aluminio fundido, plástico · Pressofusione di alluminio, plastica ·
Fonta aluminiu, plastic · Valualumiini, muovi · Barwione aluminium, plastik

Incl.:

LED E27, 4,9 W
470 lm, 3.000 K



42 | Anthrazit · anthracite



Wandleuchte · Wall lamp
incl. LED E27
4,9 W / 470 Lumen
3.000 Kelvin
228060142

IP54

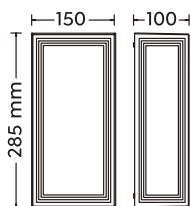

INDUS

Aluminium Druckguss, Kunststoff · Diecast aluminium, plastic ·
Fonte d'aluminium, plastique · Gegoten aluminium, kunststof ·
Aluminio fundido, plástico · Pressofusione di alluminio, plastica ·
Fonta aluminiu, plastic · Valualumiini, muovi · Barwione aluminium, plastik

42 | Anthrazit · anthracite



Wandleuchte · Wall lamp
incl. 2 x SMD-LED
2 x 4 W / 2 x 500 Lumen
3.000 Kelvin
227360142

IP54

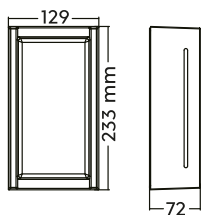

BREG

Aluminium Druckguss, Kunststoff · Diecast aluminium, plastic ·
Fonte d'aluminium, plastique · Gegoten aluminium, kunststof ·
Aluminio fundido, plástico · Pressofusione di alluminio, plastica ·
Fonta aluminiu, plastic · Valualumiini, muovii · Barwione aluminium, plastik

● 42 | Anthrazit · anthracite



Wandleuchte · Wall lamp
incl. SMD-LED
8,5 W / 850 Lumen
3.000 Kelvin
227260142

⊕ IP54

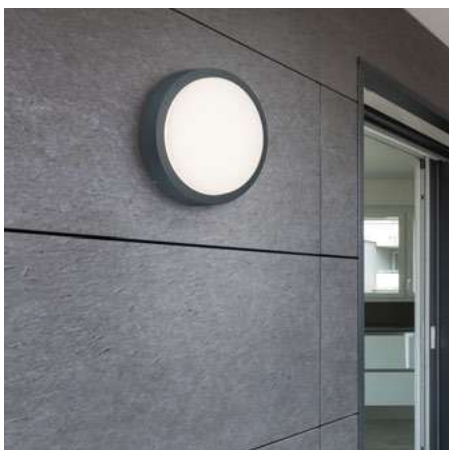
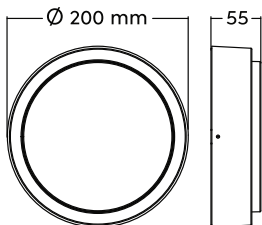

TURIA

Aluminium Druckguss, Glas · Diecast aluminium, glass ·

Fonte d'aluminium, verre · Gegoten aluminium, glas · Aluminio fundido, vidrio ·

Pressofusione di alluminio, vetro · Fonta aluminii, sticla · Valualumiini, lasi · Barwione aluminium, szkło

● 24 | rostfarbig · rusty

○ 31 | Weiß matt · white mat

● 42 | Anthrazit · anthracite



Wandleuchte · Wall lamp

excl. 2 x GU10
max. 5 W

2602602**24**

2602602**31**

2602602**42**

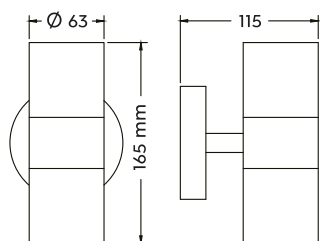

YAMUNA



Aluminium Druckguss · Diecast aluminium ·

Fonte d'aluminium · Gegoten aluminium · Aluminio fundido

Pressofusione di alluminio · Fonta aluminii · Valualumiini · Barwione aluminium

● 24 | rostfarbig · rusty

○ 31 | Weiß matt · white mat

● 42 | Anthrazit · anthracite



Wandleuchte · Wall lamp

excl. 2 x GU10
max. 10 W

2697602**24**

2697602**31**

2697602**42**

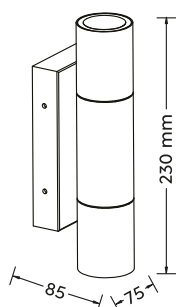

PARANA

Aluminium Druckguss · Diecast aluminium ·
 Fonte d'aluminium · Gegoten aluminium · Aluminio fundido
 Pressofusione di alluminio · Fonta aluminiu · Valualumiini · Barwione aluminium

○ 31 | Weiß matt · white mat

● 42 | Anthrazit · anthracite

Empfohlen:
 recommended:

LED GU10, 4,5 W
 345 lm, 3.000 K
 ≥ 36°



956-5936



Wandleuchte · Wall lamp
 excl. 1 x GU10
 max. 5 W
 269560131
 269560142

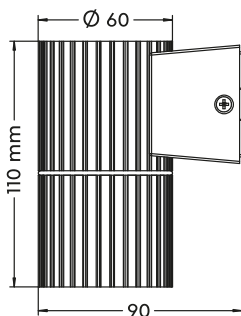

Wandleuchte · Wall lamp
 excl. 2 x GU10
 max. 5 W
 269560231
 269560242

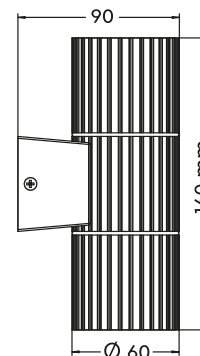

TAY

Aluminium Druckguss · Diecast aluminium ·

Fonte d'aluminium · Gegoten aluminium · Aluminio fundido · Pressofusione di alluminio · Fonta aluminiu · Valualumiini · Barwione aluminium

42 | Anthrazit · anthracite



Wandleuchte · Wall lamp
incl. 2 x SMD-LED
2 x 4,5 W / 2 x 580 Lumen
3.000 Kelvin
226560242

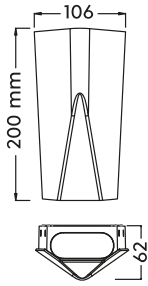

COLORADO

Aluminium Druckguss · Diecast aluminium ·

Fonte d'aluminium · Gegoten aluminium · Aluminio fundido · Pressofusione di alluminio · Fonta aluminiu · Valualumiini · Barwione aluminium

42 | Anthrazit · anthracite



Wandleuchte · Wall lamp
incl. 2 x SMD-LED
2 x 3 W / 2 x 300 Lumen
3.000 Kelvin
228460242

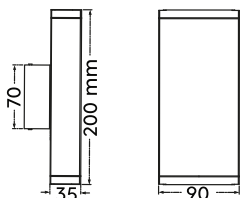

ARDAS

Aluminium Druckguss, Glas · Diecast aluminium, glass ·

Fonte d'aluminium, verre · Gegoten aluminium, glas · Aluminio fundido, vidrio ·

Pressofusione di alluminio, vetro · Fonta aluminii, sticla · Valualumiini, lasi · Barwione aluminium, szkło

● 32 | Schwarz matt · black mat

Empfohlen:
recommended:

LED GU10, 4,9 W
430 lm, 3.000 K
≥ 110°



955-50



Wandleuchte · Wall lamp
excl. 2 x GU10
max. 10 W
212560**32**

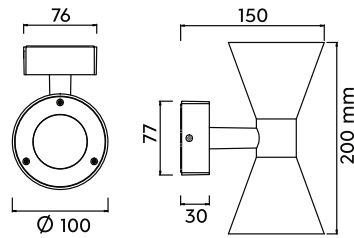

TIBER

Aluminium Druckguss · Diecast aluminium ·

Fonte d'aluminium · Gegoten aluminium · Aluminio fundido · Pressofusione di alluminio · Fonta aluminii · Valualumiini · Barwione aluminium

● 42 | Anthrazit · anthracite



Wandleuchte · Wall lamp
incl. SMD-LED
3 W / 300 Lumen
3.000 Kelvin
229160**42**

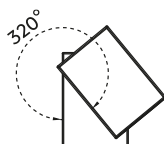
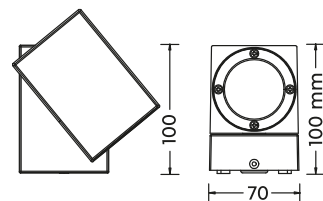

KAVERI

Aluminium Druckguss · Diecast aluminium ·
 Fonte d'aluminium · Gegoten aluminium · Aluminio fundido
 Pressofusione di alluminio · Fonta aluminiu · Valualumiini · Barwione aluminium

42 | Anthrazit · anthracite



Wandleuchte · Wall lamp
 excl. 1 x GU10
 max. 5 W
206060142

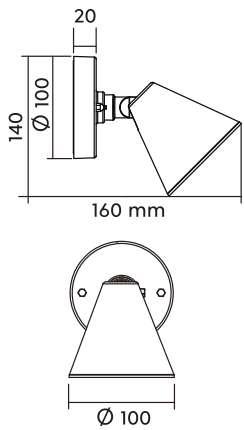

Sockelleuchte · Pedestal lamp
 excl. 1 x GU10
 max. 5 W
506060142

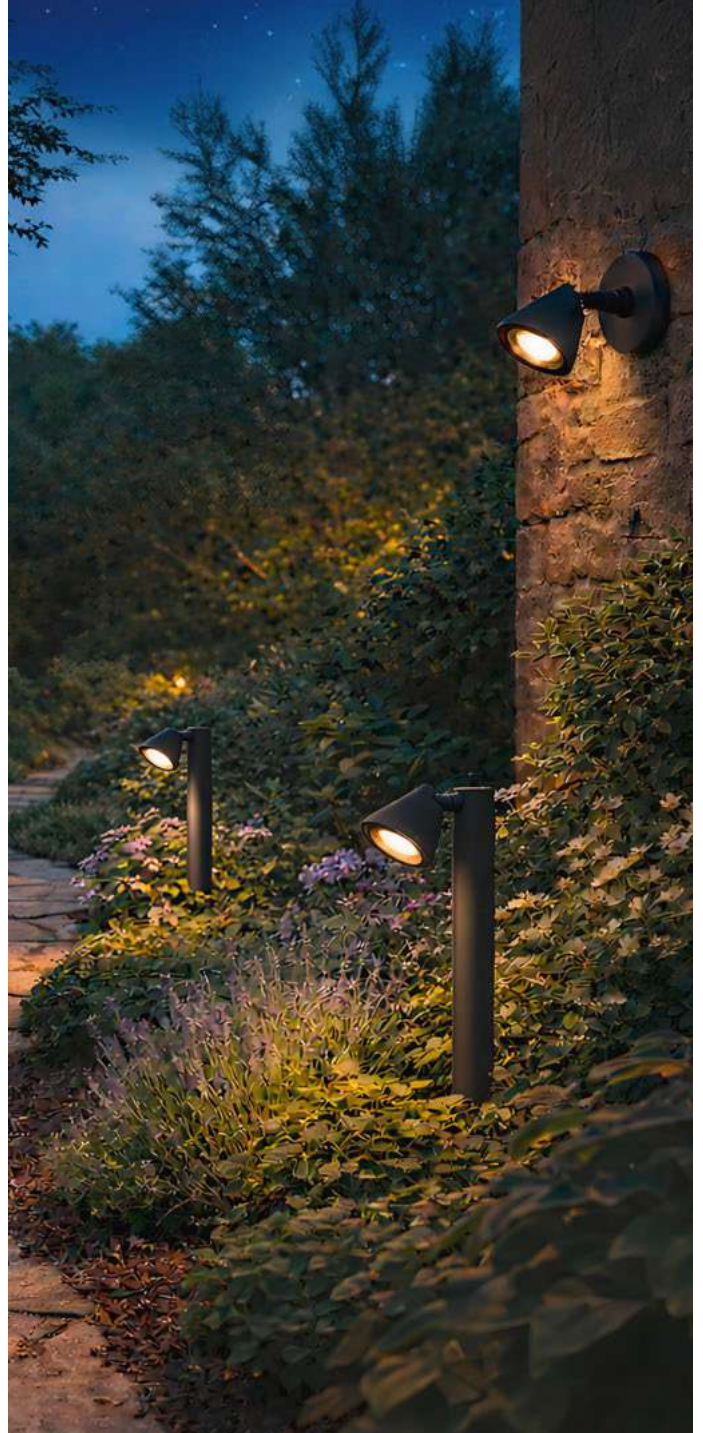
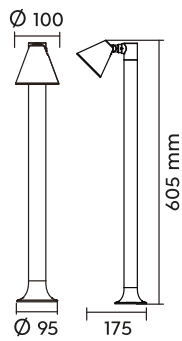

Empfohlen:
 recommended:

LED GU10, 4,9 W
 430 lm, 3.000 K
 ≥ 110°

955-50



Metall, Glas · Metal, glass ·
 Metale, verre · Metaal, glas · Metal, vidrio ·
 Metallo, vetro · Metal, sticla · Metalli, lasi · Metal, szkło

 **31** | Weiß matt · white mat

 **42** | Anthrazit · anthracite

Empfohlen:
recommended:

LED GU10, 4,5 W
345 lm, 3.000 K
≥ 36°



 **956-5936**



Wandleuchte · Wall lamp
 excl. 1 x GU10
 max. 5 W
260360131
260360142

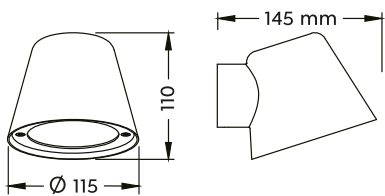

Sockelleuchte · Podestal lamp
 excl. 1 x GU10
 max. 5 W
560360131
560360142

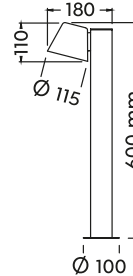

Bodenleuchte · Floor lamp
 excl. 1 x GU10
 max. 5 W
460360131
460360142

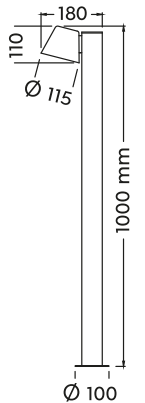

ROYA

Aluminium Druckguss · Diecast aluminium ·
 Fonte d'aluminium · Gegoten aluminium · Aluminio fundido ·
 Pressofusione di alluminio · Fonta aluminii · Valualumiini ·
 Barwione aluminium

● 42 | Anthrazit · anthracite



Bewegungssensor ·
 Motion sensor

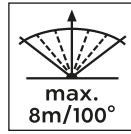

Empfohlen:
 recommended:

LED GU10, 4,9 W
 430 lm, 3.000 K
 > 110°



955-50



Wandleuchte · Wall lamp
 excl. 1 x GU10
 max. 35 W
214260142

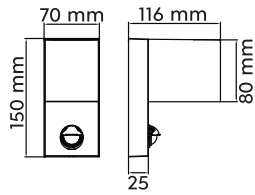

Wandleuchte · Wall lamp
 excl. 1 x GU10
 max. 35 W
214269142

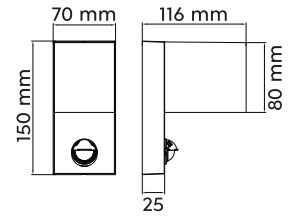

Wandleuchte · Wall lamp
 excl. 2 x GU10
 max. 35 W
214260242

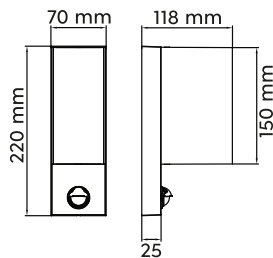

Wandleuchte · Wall lamp
 excl. 2 x GU10
 max. 35 W
214269242

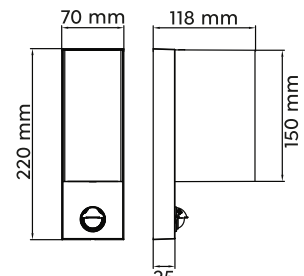

Sockelleuchte · Pedestal lamp
 excl. 1 x GU10
 max. 35 W
514260142

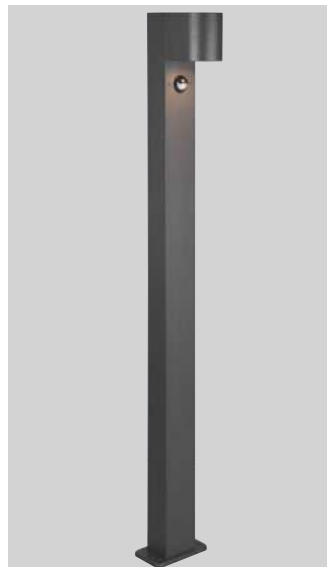
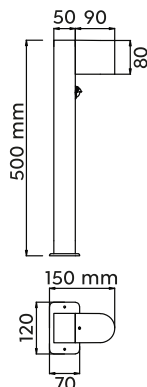

Bodenleuchte · Floor lamp
 excl. 1 x GU10
 max. 35 W
414260142

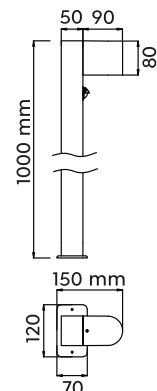



ROYA

Aluminium Druckguss · Diecast aluminium ·
 Fonte d'aluminium · Gegoten aluminium · Aluminio fundido ·
 Pressofusione di alluminio · Fonta aluminu · Valualumiini · Barwione aluminium

- 24** | rostfarbig · rusty
- 31** | Weiß matt · white mat
- 42** | Anthrazit · anthracite

Empfohlen:
recommended:

LED GU10, 4,9 W
430 lm, 3.000 K
≥ 110°



955-50



Wandleuchte · Wall lamp
 excl. 2 x GU10
 max. 35 W
204260224
204260231
204260242

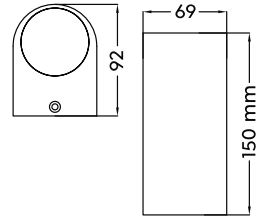

Wandleuchte · Wall lamp
 excl. 2 x GU10
 max. 35 W
204269224
204269231
204269242

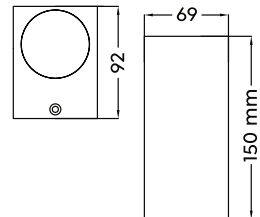

Sockelleuchte · Podestal lamp
 excl. 1 x GU10
 max. 20 W
504260142

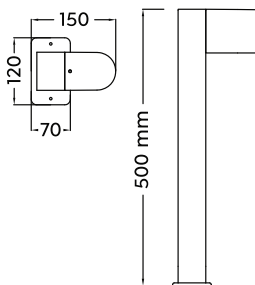

Bodenleuchte · Floor lamp
 excl. 1 x GU10
 max. 20 W
404260142

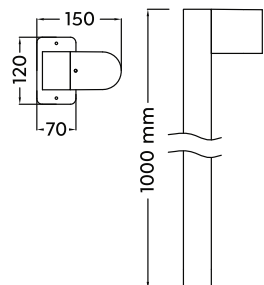



MAAS

Aluminium Druckguss, Kunststoff · Diecast aluminium, plastic ·
Fonte d'aluminium, plastique · Gegoten aluminium, kunststof ·
Aluminio fundido, plástico · Pressofusione di alluminio, plastica ·
Fonta aluminiu, plastic · Valualumiini, muov · Barwione aluminium, plastik

 **15** | Grün · green

 **42** | Anthrazit · anthracite

 **24** | rostfarbig · rusty

 **66** | Sand · sable

 **40** | Apricot · apricot



Wandleuchte · Wall lamp

excl. 1 x E27
max. 10 W

2624601**15**

2624601**24**

2624601**40**

2624601**42**

2624601**66**

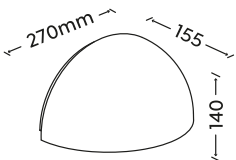

ELBE

Aluminium Druckguss, Kunststoff · Diecast aluminium, plastic ·
Fonte d'aluminium, plastique · Gegoten aluminium, kunststof ·
Aluminio fundido, plástico · Pressofusione di alluminio, plastica ·
Fonta aluminiu, plastic · Valualumiini, muovii · Barwione aluminium, plastik

 **15** | Grün · green

 **42** | Anthrazit · anthracite

 **24** | rostfarbig · rusty

 **66** | Sand · sable

 **40** | Apricot · apricot



Wandleuchte · Wall lamp

excl. 1 x E27
max. 10 W

2623601**15**

2623601**24**

2623601**40**

2623601**42**

2623601**66**

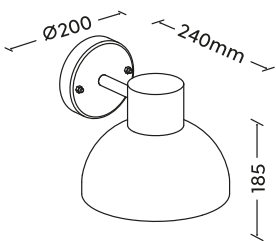

VOLGA

Aluminium Druckguss, Kunststoff · Diecast aluminium, plastic ·
 Fonte d'aluminium, plastique · Gegoten aluminium, kunststof ·
 Aluminio fundido, plástico · Pressofusione di alluminio, plastica ·
 Fonta aluminiu, plastic · Valualumiini, muov · Barwione aluminium, plastik

42 | Anthrazit · anthracite



Bewegungssensor ·
 Motion sensor



Wandleuchte · Wall lamp
 excl. 1 x E27
 max. 25 W
269469142

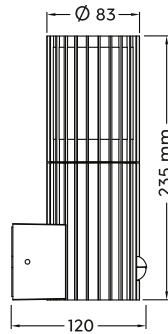

Wandleuchte · Wall lamp
 excl. 1 x E27
 max. 25 W
269460142

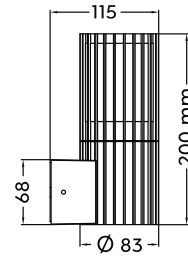

Wandleuchte · Wall lamp
 excl. 2 x E27
 max. 25 W
269460242

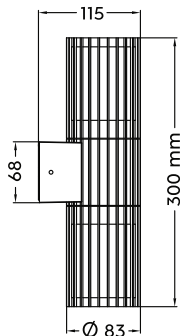

Bodenleuchte · Floor lamp
 excl. 1 x E27
 max. 25 W
469460142

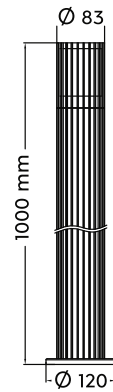

Sockelleuchte · Pedestal lamp
 excl. 1 x E27
 max. 25 W
569460142





TRIOTO

Edelstahl, Kunststoff · Steel, plastic ·
 Acier, plastique · Staal, kunststof · Acero, plástico ·
 Acciaio, plastica · Inox, plastic · Teräs, muovi · Stal, plastik



Bewegungssensor ·
 Motion sensor

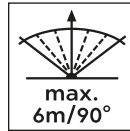

07 | Nickel matt · nickel mat

32 | Schwarz matt · black mat



Wandleuchte · Wall lamp
 excl. 1 x E27
 max. 25 W
 209760107
 209760132

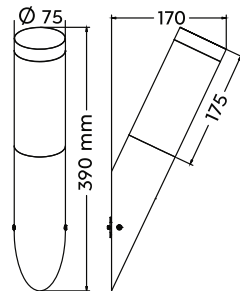

Wandleuchte · Wall lamp
 excl. 1 x E27
 max. 25 W
 209769107
 209769132

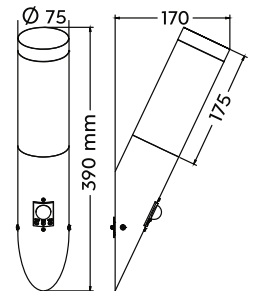

Sockelleuchte · Podestal lamp
 excl. 1 x E27
 max. 25 W
 509760107
 509760132

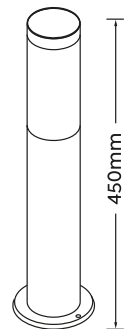

Bodenleuchte · Floor lamp
 excl. 1 x E27
 max. 25 W
 409760107
 409760132





ARDILA

Aluminium Druckguss, Glas · Diecast aluminium, glass ·
 Fonte d'aluminium, verre · Gegoten aluminium, glas ·
 Aluminio fundido, vidrio · Pressofusione di alluminio, vetro ·
 Fonta aluminiu, sticla · Valualumiini, lasi · Barwione aluminium, szkło

● 32 | Schwarz matt · black mat

Empfohlen:
 recommended:

Filament LED
 E27, 4 W
 470 lm, 2.700 K



987-400



Wandleuchte · Wall lamp
 excl. 1 x E27
 max. 40 W
211660132

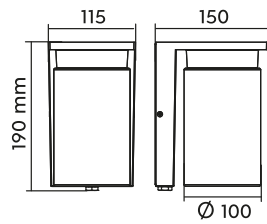

Sockelleuchte · Podestal lamp
 excl. 1 x E27
 max. 40 W
511660132

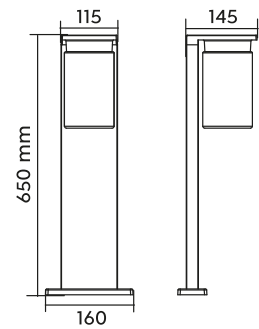

Bodenleuchte · Floor lamp
 excl. 1 x E27
 max. 40 W
411660132

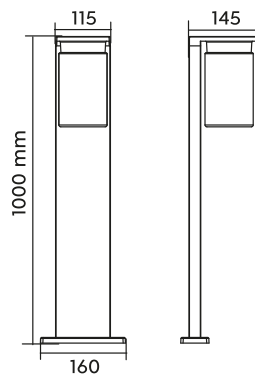

● Dämmerungssensor
 per Schalter deaktivierbar ·
 On and off switchable
 dusk sensor





ARDILA

Aluminium Druckguss, Glas · Diecast aluminium, glass ·
 Fonte d'aluminium, verre · Gegoten aluminium, glas ·
 Aluminio fundido, vidrio · Pressofusione di alluminio, vetro ·
 Fonta aluminiu, sticla · Valualumiini, lasi · Barwione aluminium, szkło

 **35** | Holznachbildung · wood imitation

Empfohlen:
recommended:

Filament LED
E27, 4 W
470 lm, 2.700 K



987-400



Wandleuchte · Wall lamp
excl. 1 x E27
max. 40 W
211660135

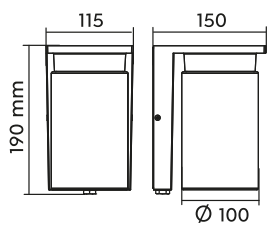

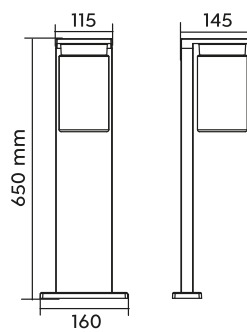

Sockelleuchte · Podestal lamp
excl. 1 x E27
max. 40 W
511660135

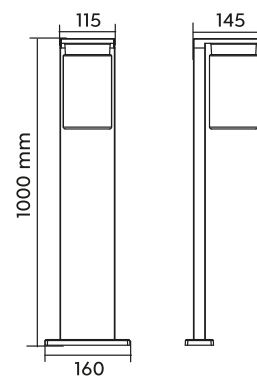

Bodenleuchte · Floor lamp
excl. 1 x E27
max. 40 W
411660135



 Dämmerungssensor
per Schalter deaktivierbar ·
 On and off switchable
dusk sensor

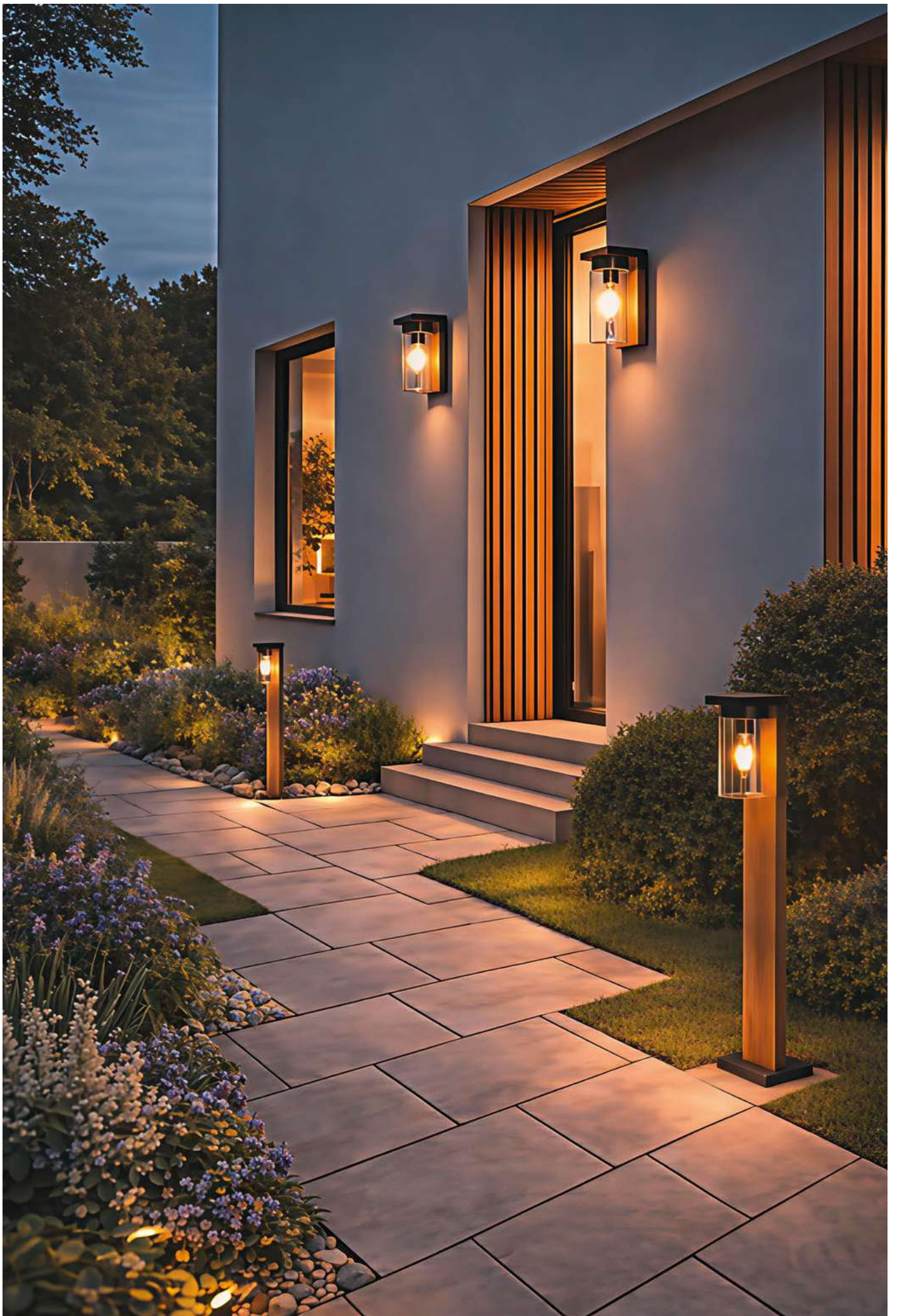

COOPER

Edelstahl, Kunststoff · Steel, plastic ·

Acier, plastique · Staal, kunststof · Acero, plástico ·

Acciaio, plastica · Inox, plastic · Teräs, muovi · Stal, plastik

42 | Anthrazit · anthracite

Empfohlen:
recommended:

Filament LED
E27, 4 W
470 lm, 2.700 K



987-400



Wandleuchte · Wall lamp

excl. 1 x E27
max. 40 W

207360142

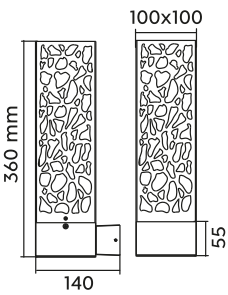

Sockelleuchte · Podestal lamp

excl. 1 x E27
max. 40 W

507360142

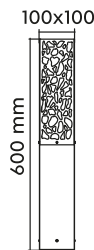

Bodenleuchte · Floor lamp

excl. 1 x E27
max. 40 W

407360142

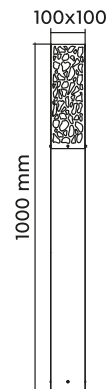



FRASER

Aluminium Druckguss · Diecast aluminium ·
 Fonte d'aluminium · Gegoten aluminium · Aluminio fundido
 Pressofusione di alluminio · Fonta aluminu · Valualumiini · Barwione aluminium



Bewegungssensor ·
 Motion sensor

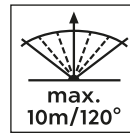

Wandleuchte · Wall lamp
 excl. 1 x E27
 max. 10 W
262569178

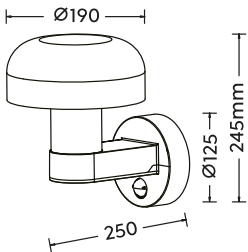

Wandleuchte · Wall lamp
 excl. 1 x E27
 max. 10 W
262560178

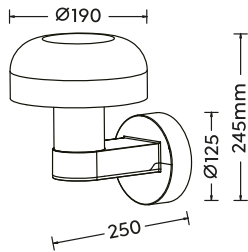

Sockelleuchte · Pedestal lamp
 excl. 1 x E27
 max. 10 W
562560178

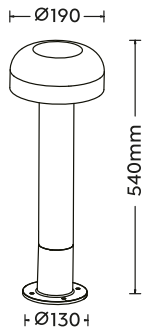

Bodenleuchte · Floor lamp
 excl. 1 x E27
 max. 10 W
462560178





FRASER

Aluminium Druckguss · Diecast aluminium ·
 Fonte d'aluminium · Gegoten aluminium · Aluminio fundido
 Pressofusione di alluminio · Fonta aluminu · Valualumiini · Barwione aluminium



Bewegungssensor ·
 Motion sensor

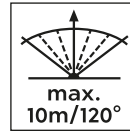

Wandleuchte · Wall lamp
 excl. 1 x E27
 max. 10 W
262569135

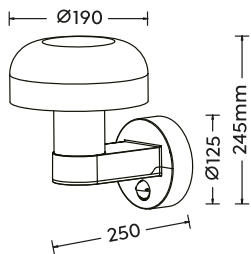

Wandleuchte · Wall lamp
 excl. 1 x E27
 max. 10 W
262560135

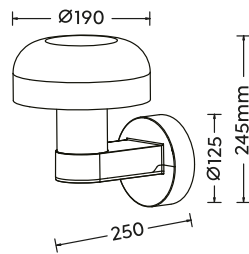

Sockelleuchte · Pedestal lamp
 excl. 1 x E27
 max. 10 W
562560135

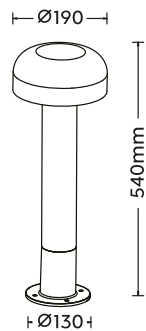

Bodenleuchte · Floor lamp
 excl. 1 x E27
 max. 10 W
462560135

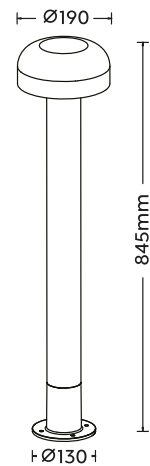



MURES

Aluminium Druckguss, Glas · Diecast aluminium, glass ·
 Fonte d'aluminium, verre · Gegoten aluminium, glas ·
 Aluminio fundido, vidrio · Pressofusione di alluminio, vetro ·
 Fonta aluminiu, sticla · Valualumiini, lasi · Barwione aluminium, szkło



Bewegungssensor ·
 Motion sensor

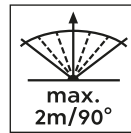

42 | Anthrazit · anthracite



Wandleuchte · Wall lamp
 excl. 1 x E27
 max. 40 W
269860142

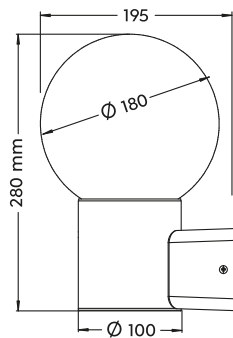

Wandleuchte · Wall lamp
 excl. 1 x E27
 max. 40 W
269869142

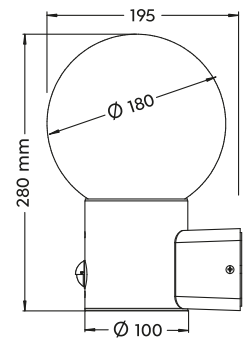

Sockelleuchte · Pedestal lamp
 excl. 1 x E27
 max. 40 W
569860142

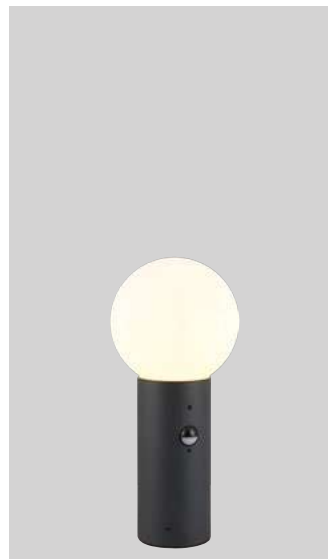
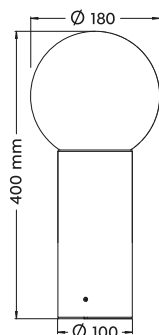

Sockelleuchte · Pedestal lamp
 excl. 1 x E27
 max. 40 W
569869142

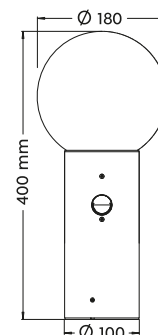

Bodenleuchte · Floor lamp
 excl. 1 x E27
 max. 40 W
469860142



Bodenleuchte · Floor lamp
 excl. 1 x E27
 max. 40 W
469869142

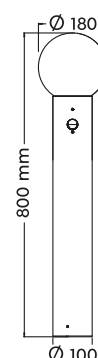



HOOSIC

Aluminium Druckguss, Kunststoff · Diecast aluminium, plastic ·
 Fonte d'aluminium, plastique · Gegoten aluminium, kunststof ·
 Aluminio fundido, plástico · Pressofusione di alluminio, plastica ·
 Fonta aluminiu, plastic · Valualumiini, muovi ·
 Barwione aluminium, plastik

42 | Anthrazit · anthracite

Empfohlen:
 recommended:

LED E27, 4,9 W
 470 lm, 3.000 K



987-60



Wandleuchte · Wall lamp
 excl. 1 x E27
 max. 28 W
222260142

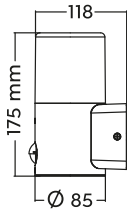

Wandleuchte · Wall lamp
 excl. 2 x E27
 max. 28 W
222260242

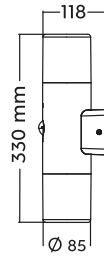

Sockelleuchte · Pedestal lamp
 excl. 1 x E27
 max. 28 W
522260142

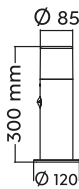

Bodenleuchte · Floor lamp
 excl. 1 x E27
 max. 28 W
422260142

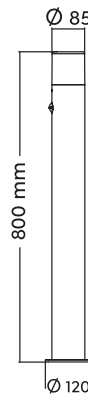



HOOSIC

Aluminium Druckguss, Kunststoff · Diecast aluminium, plastic ·
 Fonte d'aluminium, plastique · Gegoten aluminium, kunststof ·
 Aluminio fundido, plástico · Pressofusione di alluminio, plastica ·
 Fonta aluminiu, plastic · Valualumiini, muovi · Barwione aluminium, plastik

● 42 | Anthrazit · anthracite

Empfohlen:
recommended:

LED E27, 4,9 W
470 lm, 3.000 K



987-60



Wandleuchte · Wall lamp
 excl. 1 x E27
 max. 28 W
224060142

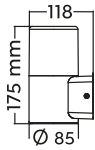

Wandleuchte · Wall lamp
 excl. 2 x E27
 max. 28 W
224060242

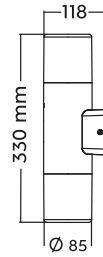

Wandleuchte · Wall lamp
 excl. 1 x E27
 max. 28 W
524060142

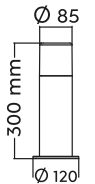

Wandleuchte · Wall lamp
 excl. 1 x E27
 max. 28 W
424060142

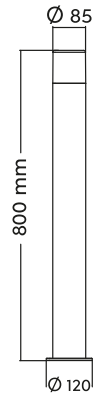

HOOSIC

Aluminium Druckguss, Kunststoff · Diecast aluminium, plastic ·
Fonte d'aluminium, plastique · Gegoten aluminium, kunststof ·
Aluminio fundido, plástico · Pressofusione di alluminio, plastica ·
Fonta aluminiu, plastic · Valualumiini, muovi · Barwione aluminium, plastik



42 | Anthrazit · anthracite



Bodenleuchte · Floor lamp

excl. 1 x E27

max. 28 W

424067142



IP44

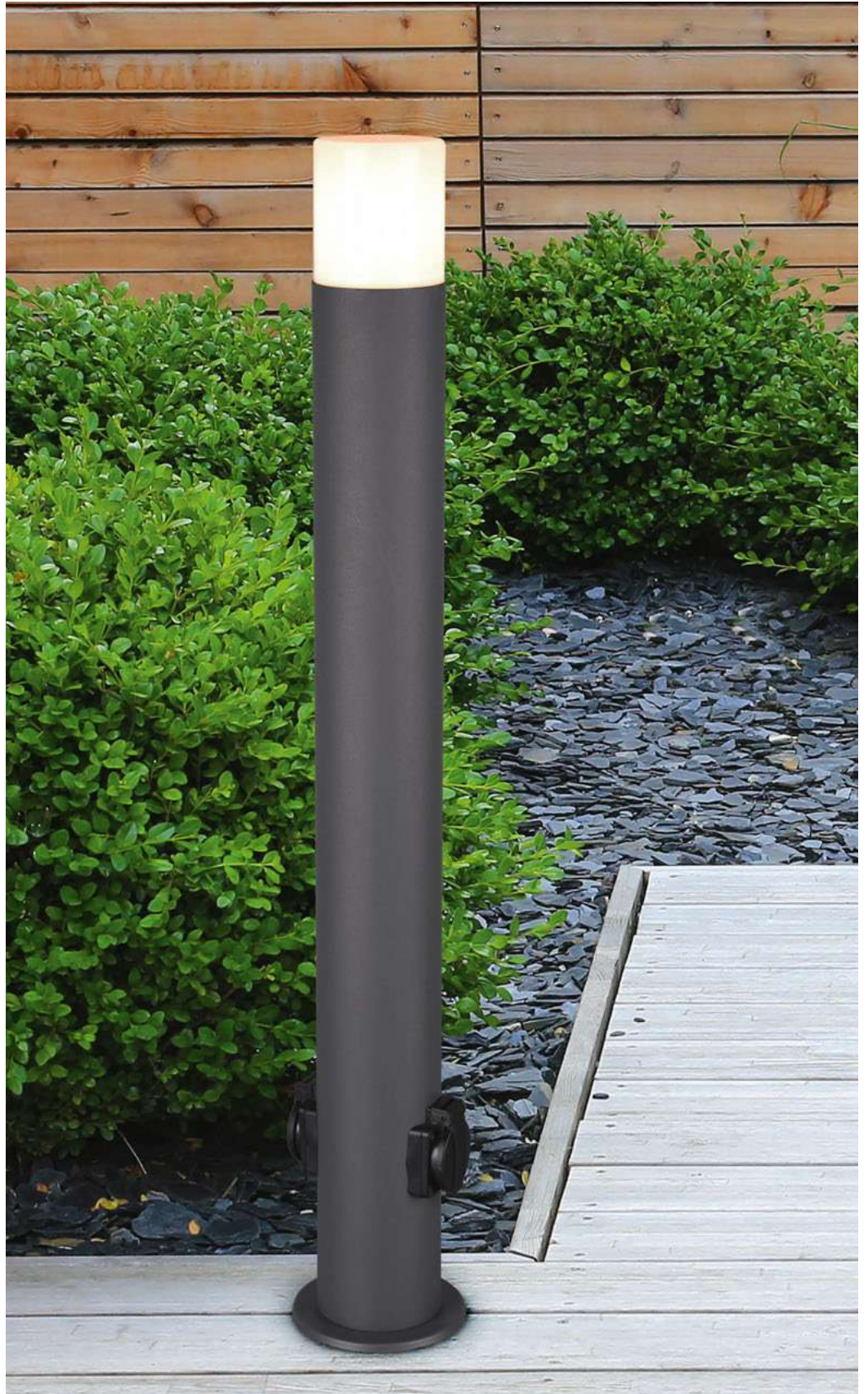

HOOSIC

Aluminium Druckguss, Kunststoff · Diecast aluminium, plastic ·
Fonte d'aluminium, plastique · Gegoten aluminium, kunststof ·
Aluminio fundido, plástico · Pressofusione di alluminio, plastica ·
Fonta aluminiu, plastic · Valualumiini, muov · Barwione aluminium, plastik

 24 | rostfarbig · rusty

Empfohlen:
recommended:

LED E27, 4,9 W
470 lm, 3.000 K



987-60



Wandleuchte · Wall lamp
excl. 1 x E27
max. 28 W
222260124

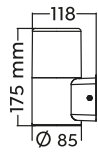

Wandleuchte · Wall lamp
excl. 2 x E27
max. 28 W
222260224

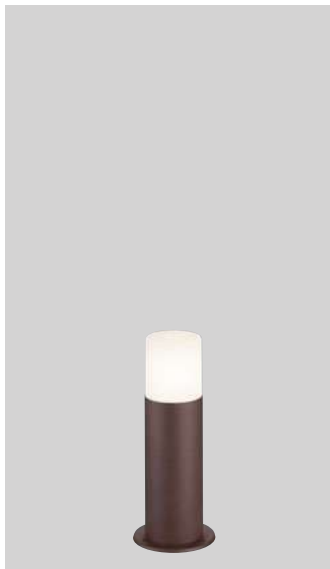
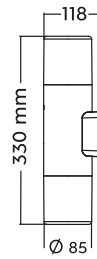

Sockelleuchte · Podestal lamp
excl. 1 x E27
max. 28 W
522260124



Bodenleuchte · Floor lamp
excl. 1 x E27
max. 28 W
422260124





HOOSIC

Aluminium Druckguss, Kunststoff · Diecast aluminium, plastic ·
Fonte d'aluminium, plastique · Gegoten aluminium, kunststof ·
Aluminio fundido, plástico · Pressofusione di alluminio, plastica ·
Fonta aluminiu, plastic · Valualumiini, muovi · Barwione aluminium, plastik

● 32 | Schwarz matt · black mat



Wandleuchte · Wall lamp
excl. 1 x E27
max. 28 W
224060132

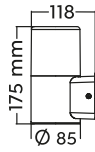

Wandleuchte · Wall lamp
excl. 2 x E27
max. 28 W
224060232

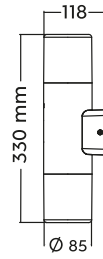

Sockelleuchte · Pedestal lamp
excl. 1 x E27
max. 28 W
524060132

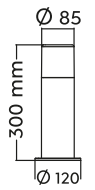

Bodenleuchte · Floor lamp
excl. 2 x E27
max. 28 W
424060132



HOOSIC

Aluminium Druckguss, Kunststoff · Diecast aluminium, plastic ·
 Fonte d'aluminium, plastique · Gegoten aluminium, kunststof ·
 Aluminio fundido, plástico · Pressofusione di alluminio, plastica ·
 Fonta aluminiu, plastic · Valualumiini, muovii · Barwione aluminium, plastik



Bewegungssensor ·
 Motion sensor



32 | Schwarz matt · black mat



Wandleuchte · Wall lamp
 excl. 1 x E27
 max. 28 W
222260132

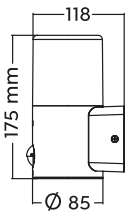

Wandleuchte · Wall lamp
 excl. 2 x E27
 max. 28 W
222260232

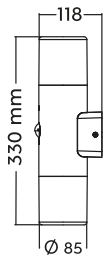

HUDSON

Aluminium Druckguss, Kunststoff · Diecast aluminium, plastic ·
Fonte d'aluminium, plastique · Gegoten aluminium, kunststof ·
Aluminio fundido, plástico · Pressofusione di alluminio, plastica ·
Fonta aluminiu, plastic · Valualumiini, muovi · Barwione aluminium, plastik

Incl.:

LED E14, 3,5 W
320 lm, 3.000 K



42 | Anthrazit · anthracite



Sockelleuchte · Pedestal lamp

incl. LED E14
3,5 W / 320 Lumen
3.000 Kelvin
5200601**42**



Bodenleuchte · Floor lamp

incl. LED E14
3,5 W / 320 Lumen
3.000 Kelvin
4200601**42**



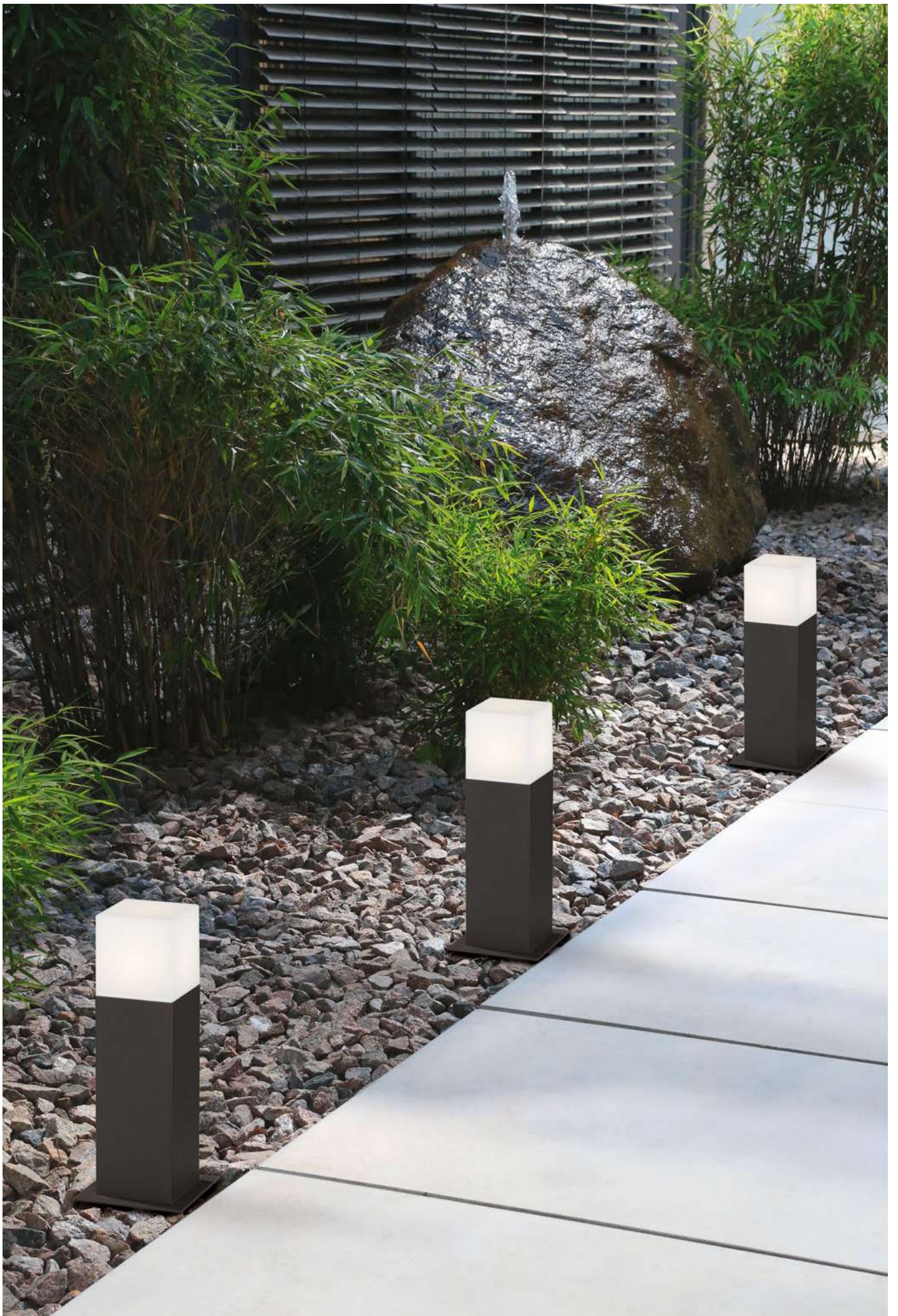

CAVADO

Aluminium Druckguss, Kunststoff · Diecast aluminium, plastic ·
 Fonte d'aluminium, plastique · Gegoten aluminium, kunststof ·
 Aluminio fundido, plástico · Pressofusione di alluminio, plastica ·
 Fonta aluminiu, plastic · Valualumiini, muovii · Barwione aluminium, plastik

● 42 | Anthrazit · anthracite



Bewegungssensor ·
 Motion sensor

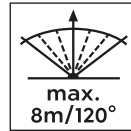

Empfohlen:
 recommended:

Filament LED
 E27, 4 W
 470 lm, 2.700 K



987-400



Wandleuchte · Wall lamp
 excl. 1 x E27
 max. 40 W
 211060142



Wandleuchte · Wall lamp
 excl. 1 x E27
 max. 40 W
 211069142



Bodenleuchte · Floor lamp
 excl. 1 x E27
 max. 40 W
 411060142

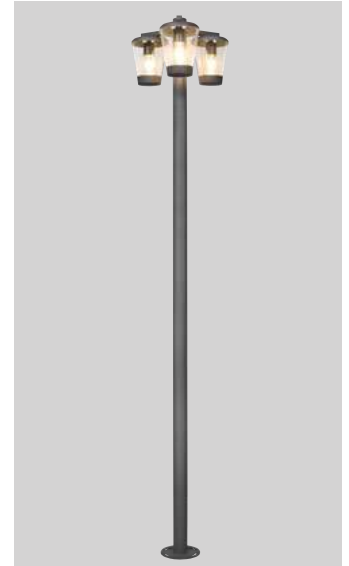

Bodenleuchte · Floor lamp
 excl. 3 x E27
 max. 40 W
 411060342

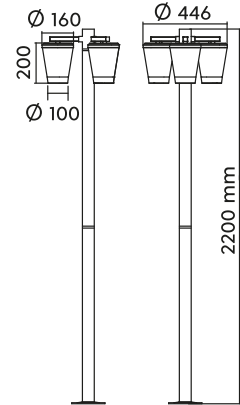
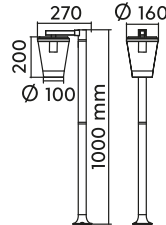
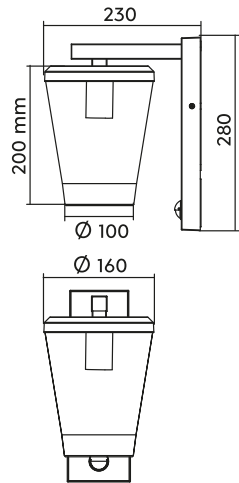
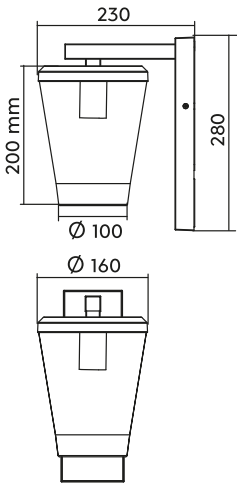



SAMBESI

Aluminium Druckguss, Acryl · Diecast aluminium, acryl ·
 Fonte d'aluminium, acryl · Gegoten aluminium, acryl ·
 Aluminio fundido, acrílico · Pressofusione di alluminio, acrilico ·
 Fonta aluminiu, acrilic · Valualumiini, akryyli · Barwione aluminium, akryl

● 42 | Anthrazit · anthracite

Empfohlen:
 recommended:

Filament LED
 E27, 4 W
 470 lm, 2.700 K



987-400



Wandleuchte · Wall lamp

excl. 1 x E27
 max. 28 W

204160142

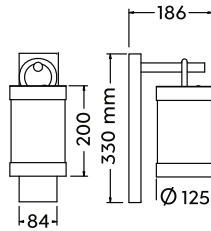

Sockelleuchte · Podestal lamp

excl. 1 x E27
 max. 28 W

504160142

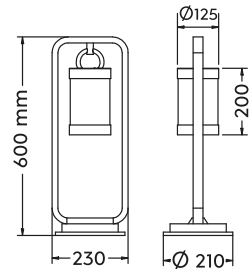

Bodenleuchte · Floor lamp

excl. 1 x E27
 max. 28 W

404160142

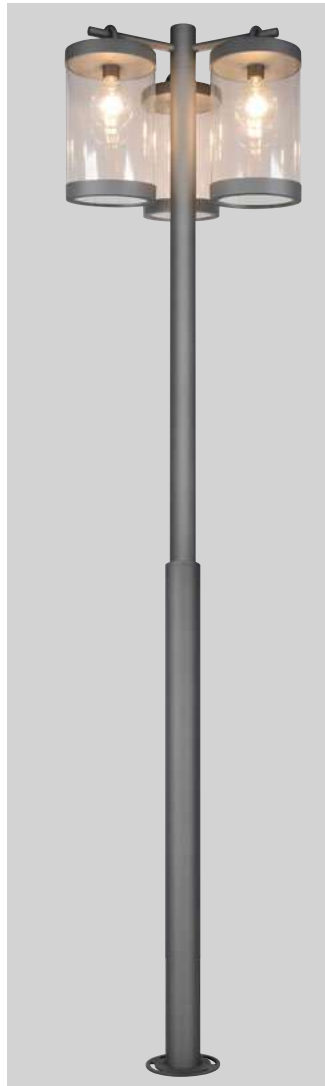
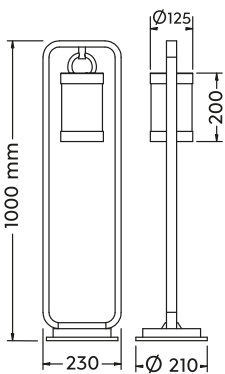

Bodenleuchte · Floor lamp

excl. 3 x E27
 max. 28 W

404160342

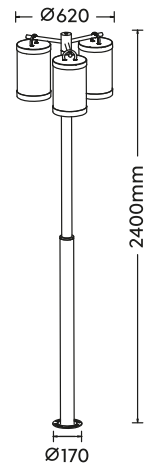

● Dämmerungssensor
 per Schalter deaktivierbar ·
 On and off switchable
 dusk sensor



Wandleuchte · Wall lamp
 excl. 1 x E27
 max. 28 W
204169142

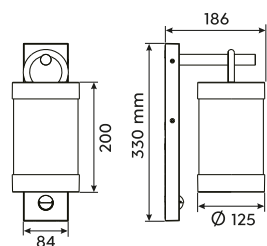

Bewegungssensor ·
 Motion sensor

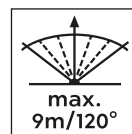

SAMBESI

Aluminium Druckguss, Acryl · Diecast aluminium, acryl ·
 Fonte d'aluminium, acryl · Gegoten aluminium, acryl ·
 Aluminio fundido, acrílico · Pressofusione di alluminio, acrilico ·
 Fonta aluminiu, acrilic · Valualumiini, akryyli · Barwione aluminium, akryl

24 | rostfarbig · rusty

Empfohlen:
 recommended:

Filament LED
 E27, 4 W
 470 lm, 2.700 K



987-400



Wandleuchte · Wall lamp

excl. 1 x E27
 max. 28 W

204160124

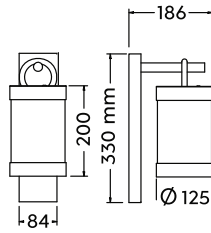

Sockelleuchte · Podestal lamp

excl. 1 x E27
 max. 28 W

504160124

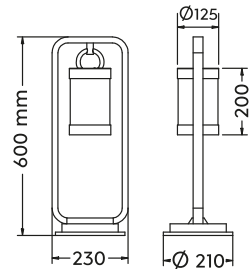

Bodenleuchte · Floor lamp

excl. 1 x E27
 max. 28 W

404160124

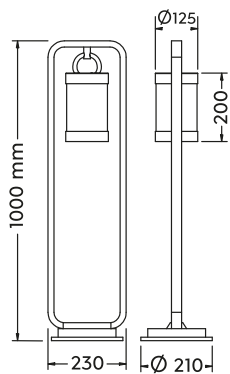



Bodenleuchte · Floor lamp

excl. 3 x E27
 max. 28 W

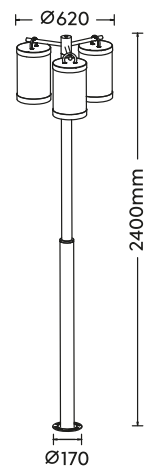
404160324



 Dämmerungssensor
 per Schalter deaktivierbar ·
 On and off switchable
 dusk sensor



Wandleuchte · Wall lamp
excl. 1 x E27
max. 28 W
204169124



 Bewegungssensor ·
Motion sensor

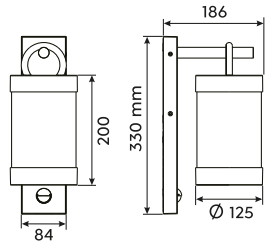
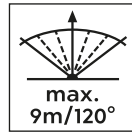

SAMBESI

Aluminium Druckguss, Acryl · Diecast aluminium, acryl ·
 Fonte d'aluminium, acryl · Gegoten aluminium, acryl ·
 Aluminio fundido, acrílico · Pressofusione di alluminio, acrilico ·
 Fonta aluminiu, acrilic · Valualumiini, akryyli · Barwione aluminium, akryl

 **31** | Weiß matt · white mat

 **35** | Holznachbildung · wood imitation

 Bewegungssensor · Motion sensor

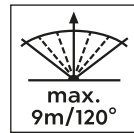

Empfohlen:
recommended:

Filament LED
E27, 4 W
470 lm, 2.700 K



987-400



31





35

Wandleuchte · Wall lamp

excl. 1 x E27
max. 28 W

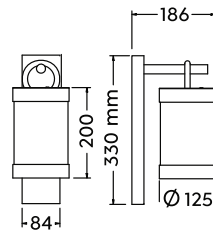
204160131
204160135



 Dämmerungssensor
per Schalter deaktivierbar ·
 On and off switchable
dusk sensor



31



35

Wandleuchte · Wall lamp

excl. 1 x E27
max. 28 W

204169131
204169135

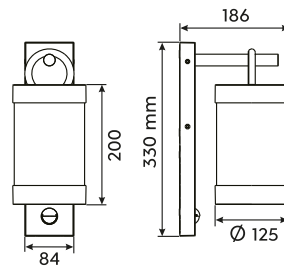

GARONNE

Aluminium Druckguss, Glas · Diecast aluminium, glass ·
 Fonte d'aluminium, verre · Gegoten aluminium, glas ·
 Aluminio fundido, vidrio · Pressofusione di alluminio, vetro ·
 Fonta aluminiu, sticla · Valualumiini, lasi · Barwione aluminium, szkło



Bewegungssensor ·
 Motion sensor

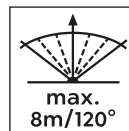

42 | Anthrazit · anthracite



Wandleuchte · Wall lamp
 excl. 1 x E27
 max. 60 W
 201869142

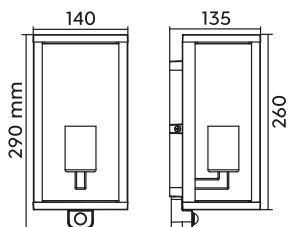

Bodenleuchte · Floor lamp
 excl. 1 x E27
 max. 60 W
 401869142

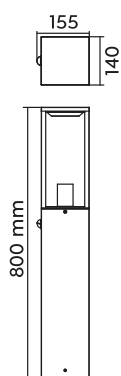

GARONNE

Aluminium Druckguss, Glas · Diecast aluminium, glass ·
 Fonte d'aluminium, verre · Gegoten aluminium, glas ·
 Aluminio fundido, vidrio · Pressofusione di alluminio, vetro ·
 Fonta aluminiu, sticla · Valualumiini, lasi · Barwione aluminium, szkło

 **24** | rostfarbig · rusty

 **42** | Anthrazit · anthracite

 **31** | Weiß matt · white mat

Empfohlen:
recommended:

Filament LED
E27, 4 W
470 lm, 2.700 K



987-400



24



31



42

Wandleuchte · Wall lamp

excl. 1 x E27
max. 60 W

201860124
201860131
201860142

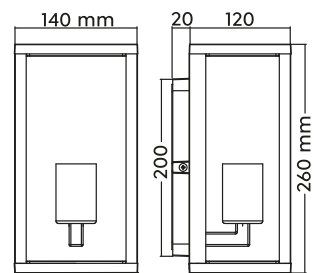

24



31



42

Wandleuchte · Wall lamp

excl. 2 x E27
max. 10 W

201860224
201860231
201860242

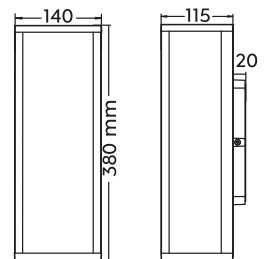

Deckenleuchte · Ceiling lamp

excl. 2 x E27
max. 10 W

601860242

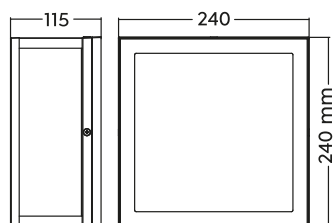

Sockelleuchte · Podestal lamp

excl. 1 x E27
max. 60 W

501860142



140 x 140

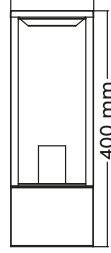

400 mm

Bodenleuchte · Floor lamp

excl. 1 x E27
max. 60 W

401860142



140 x 140

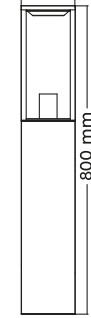

800 mm



Metall, Glas · Metal, glass ·
 Metale, verre · Metaal, glas · Metal, vidrio ·
 Metallo, vetro · Metal, sticla · Metalli, lasi · Metal, szkło

86 | zinkfarbig · zinc-colored



Wandleuchte · Wall lamp
 excl. 1 x E27
 max. 10 W
262060186

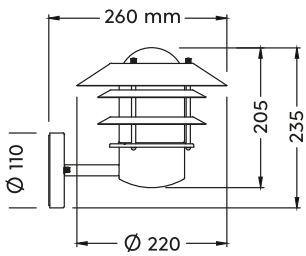

Wandleuchte · Wall lamp
 excl. 1 x E27
 max. 10 W
262067186

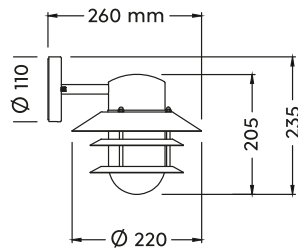

Sockelleuchte · Podestal lamp
 excl. 1 x E27
 max. 10 W
562060186

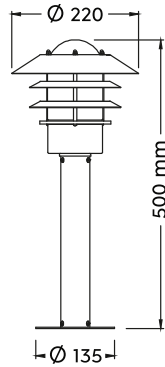

Bodenleuchte · Floor lamp
 excl. 1 x E27
 max. 10 W
462060186





BARITO



Metall zinkfarbig, Glas · Metal zinc-colored, glass ·
 Metale couleur zinc, verre · Metaal zink kleur, glas · Metal color zinc, vidrio ·
 Metallo color zinco, vetro · Metal culoarea zincului, sticla · Metalli antiikkiihopea, lasi ·
 Metal kolor cynkowy, szkło

86 | zinkfarbig · zinc-colored



Wandleuchte · Wall lamp
 excl. 2 x E27
 max. 15 W
260660286

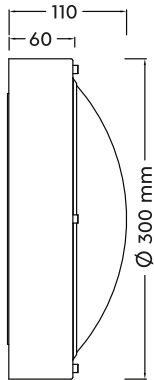

TUMEN



Metall zinkfarbig, Kunststoff · Metal zinc-colored, plastic ·
 Metale couleur zinc, plastique · Metaal zink kleur, kunststof · Metal color zinc, plástico ·
 Metallo color zinco, plastica · Metal culoarea zincului, plastic · Metalli antiikkiihopea, muovi ·
 Metal kolor cynkowy, plastik

86 | zinkfarbig · zinc-colored



Wandleuchte · Wall lamp
 excl. 1 x E27
 max. 10 W
260560186

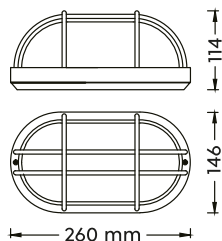

Metall zinkfarbig, Glas · Metal zinc-colored, glass ·
 Metale couleur zinc, verre · Metaal zink kleur, glas · Metal color zinc, vidrio ·
 Metallo color zinco, vetro · Metal culoarea zincului, sticla · Metalli antiikkihopea, lasi ·
 Metal kolor cynkowy, szkło

 **86** | zinkfarbig · zinc-colored

Empfohlen:
recommended:

Filament LED
E27, 4 W
470 lm, 2.700 K



987-400



Wandleuchte · Wall lamp
 excl. 1 x E27
 max. 20 W
261060186

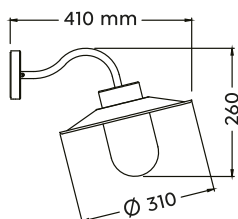

NORMAN

Aluminium Druckguss, Acryl · Diecast aluminium, acryl ·
 Fonte d'aluminium, acryl · Gegoten aluminium, acryl ·
 Aluminio fundido, acrílico · Pressofusione di alluminio, acrilico ·
 Fonta aluminiu, acrilic · Valualumiini, akryyli · Barwione aluminium, akryl

● 24 | rostfarbig · rusty

 Bewegungssensor ·
 Motion sensor

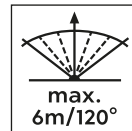

Empfohlen:
 recommended:

LED E27, 4,9 W
 470 lm, 3.000 K



987-60



Wandleuchte · Wall lamp
 excl. 1 x E27
 max. 40 W
 207269124

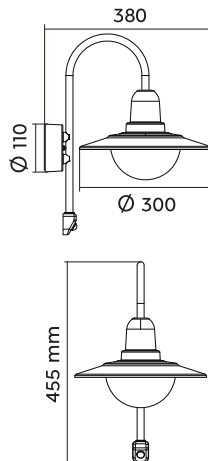

BRENTA

Aluminium Druckguss, Glas · Diecast aluminium, glass ·
 Fonte d'aluminium, verre · Gegoten aluminium, glas · Aluminio fundido, vidrio · Pressofusione di alluminio, vetro ·
 Fonta aluminiu, sticla · Valualumiini, lasi · Barwione aluminium, szkło

● 24 | rostfarbig · rusty

● 42 | Anthrazit · anthracite

○ 31 | Weiß matt · white mat

Empfohlen:
 recommended:

Filament LED
 E27, 4 W
 470 lm, 2.700 K



987-400



Wandleuchte · Wall lamp
 excl. 1 x E27
 max. 40 W
 201760124
 201760131
 201760142

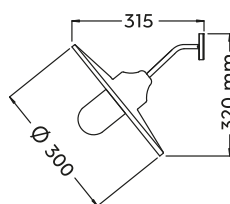

ATRATO



Aluminium · Aluminium ·
Aluminium · Aluminium · Aluminio ·
Alluminio · Aluminu · Alumiini · Aluminium

 **24** | rostfarbig · rusty

 **42** | Anthrazit · anthracite

Empfohlen:
recommended:

LED GX53, 10 W
950 lm, 4.000 K



953-1334



42

Wandleuchte · Wall lamp

excl. 1 x GX53
max. 10 W

218260124

218260142



IP44

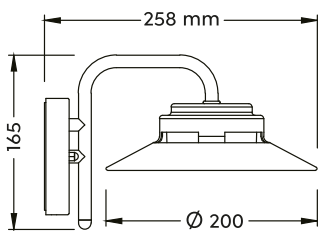

24

VOLTURNO

Aluminium Druckguss, Glas · Diecast aluminium, glass ·
 Fonte d'aluminium, verre · Gegoten aluminium, glas ·
 Aluminio fundido, vidrio · Pressofusione di alluminio, vetro ·
 Fonta aluminiu, sticla · Valualumiini, lasi · Barwione aluminium, szkło

28 | rostfarbig antik · antique rust

Empfohlen:
 recommended:

Filament LED
 E27, 4 W
 470 lm, 2.700 K



987-400



Wandleuchte · Wall lamp
 excl. 1 x E27
 max. 60 W
205960128

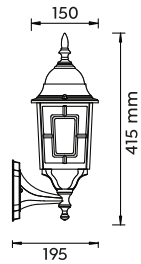

Wandleuchte · Wall lamp
 excl. 1 x E27
 max. 60 W
205967128

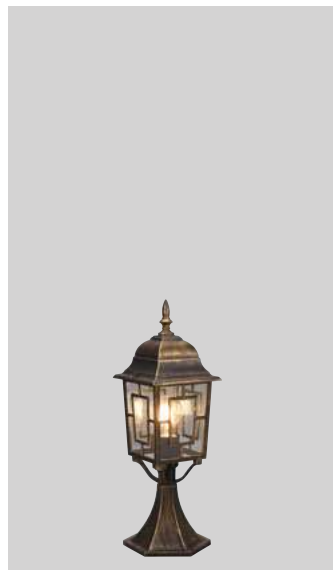
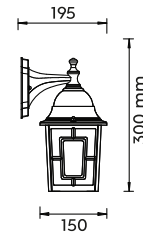

Sockelleuchte · Podestal lamp
 excl. 1 x E27
 max. 60 W
505960128

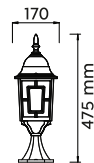

Bodenleuchte · Floor lamp
 excl. 1 x E27
 max. 60 W
405960128

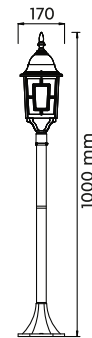

Bodenleuchte · Floor lamp
 excl. 3 x E27
 max. 60 W
405960328

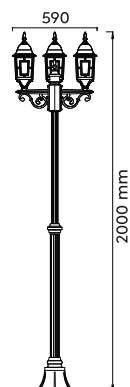



ELVO

Aluminium Druckguss, Glas · Diecast aluminium, glass ·
 Fonte d'aluminium, verre · Gegoten aluminium, glas ·
 Aluminio fundido, vidrio · Pressofusione di alluminio, vetro ·
 Fonta aluminiu, sticla · Valualumiini, lasi · Barwione aluminium, szkło

● 32 | Schwarz matt · black mat

Empfohlen:
 recommended:

Filament LED
 E27, 4 W
 470 lm, 2.700 K



987-400



Wandleuchte · Wall lamp
 excl. 1 x E27
 max. 60 W
 206960132

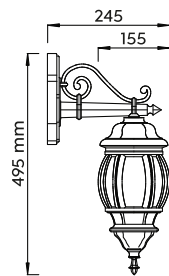

Wandleuchte · Wall lamp
 excl. 1 x E27
 max. 60 W
 206967132

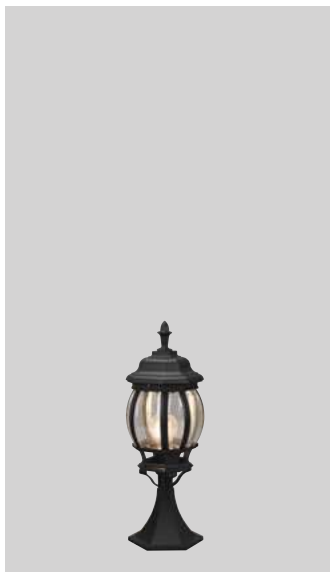
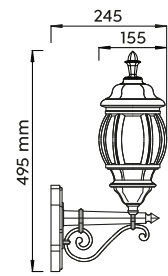

Sockelleuchte · Podestal lamp
 excl. 1 x E27
 max. 60 W
 506960132



Bodenleuchte · Floor lamp
 excl. 1 x E27
 max. 60 W
 406960132

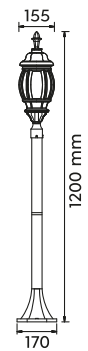

Bodenleuchte · Floor lamp
 excl. 3 x E27
 max. 60 W
 406960332

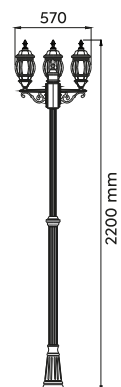



LIVENZA

Aluminium Druckguss, Glas · Diecast aluminium, glass ·
 Fonte d'aluminium, verre · Gegoten aluminium, glas ·
 Aluminio fundido, vidrio · Pressofusione di alluminio, vetro ·
 Fonta aluminiu, sticla · Valualumiini, lasi · Barwione aluminium, szkło

○ 31 | Weiß matt · white mat

● 32 | Schwarz matt · black mat

Empfohlen:
recommended:

Filament LED
E27, 4 W
470 lm, 2.700 K



987-400



Wandleuchte · Wall lamp
excl. 1 x E27
max. 60 W
205760131
205760132

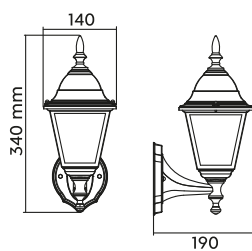

32



Wandleuchte · Wall lamp
excl. 1 x E27
max. 60 W
205767131
205767132

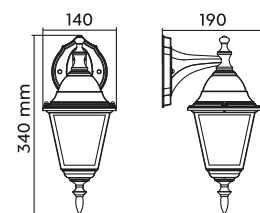

31



Sockelleuchte · Pedestal lamp
excl. 1 x E27
max. 60 W
505760131
505760132

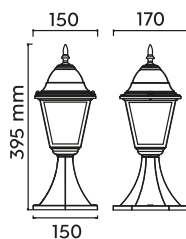

31



Bodenleuchte · Floor lamp
excl. 1 x E27
max. 60 W
405760132

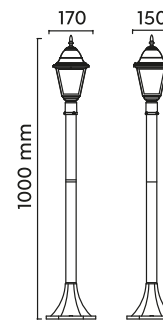

Bodenleuchte · Floor lamp
excl. 3 x E27
max. 60 W
405760332

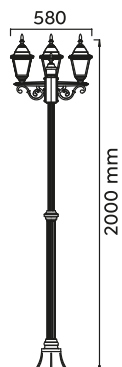



VENTA

Aluminium Druckguss, Kunststoff · Diecast aluminium, plastic ·
 Fonte d'aluminium, plastique · Gegoten aluminium, kunststof ·
 Aluminio fundido, plástico · Pressofusione di alluminio, plastica ·
 Fonta aluminiu, plastic · Valualumiini, muovu · Barwione aluminium, plastik

○ 31 | Weiß matt · white mat

● 32 | Schwarz matt · black mat

Empfohlen:
 recommended:

Filament LED
 E27, 4 W
 470 lm, 2.700 K



987-400



Wandleuchte · Wall lamp
 excl. 1 x E27
 max. 10 W
 263260131
 263260132

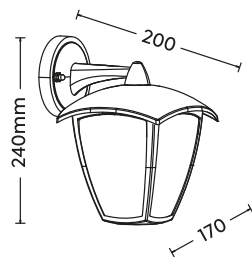

32



Wandleuchte · Wall lamp
 excl. 1 x E27
 max. 10 W
 263260231
 263260232

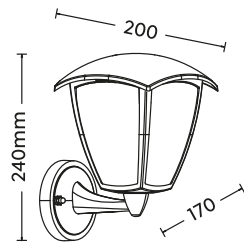

32



Sockelleuchte · Pedestal lamp
 excl. 1 x E27
 max. 10 W
 563260131
 563260132

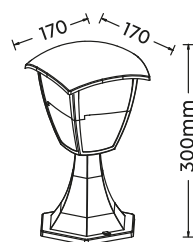

31



VENTA

Aluminium Druckguss, Kunststoff · Diecast aluminium, plastic ·
Fonte d'aluminium, plastique · Gegoten aluminium, kunststof ·
Aluminio fundido, plástico · Pressofusione di alluminio, plastica ·
Fonta aluminiu, plastic · Valualumiini, muovii · Barwione aluminium, plastik



31 | Weiß matt · white mat



32 | Schwarz matt · black mat



Pendelleuchte · Pendant

excl. 1 x E27
max. 10 W

363260131
363260132

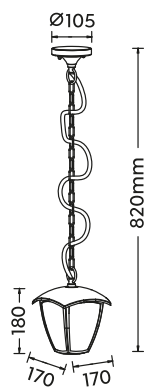

Wandleuchte · Wall lamp

excl. 1 x E27
max. 10 W

263260331
263260332

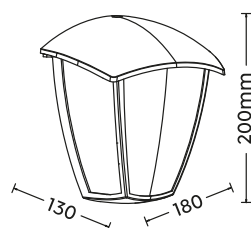

OLONA

Aluminium Druckguss, Glas · Diecast aluminium, glass ·
Fonte d'aluminium, verre · Gegoten aluminium, glas ·
Aluminio fundido, vidrio · Pressofusione di alluminio, vetro ·
Fonta aluminiu, sticla · Valualumiini, lasi · Barwione aluminium, szkło

 24 | rostfarbig · rusty

 42 | Anthrazit · anthracite

Empfohlen:
recommended:

Filament LED
E27, 4 W
470 lm, 2.700 K



987-400



24



42

Wandleuchte · Wall lamp

excl. 1 x E27
max. 40 W

201960124

201960142

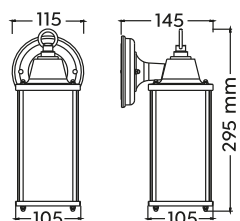

TANARO

Aluminium Druckguss, Acryl · Diecast aluminium, acryl ·
Fonte d'aluminium, acryl · Gegoten aluminium, acryl ·
Aluminio fundido, acrílico · Pressofusione di alluminio, acrilico ·
Fonta aluminiu, acrilic · Valualumiini, akryyli · Barwione aluminium, akryl

 **24** | rostfarbig · rusty

 **42** | Anthrazit · anthracite

Empfohlen:
recommended:

Filament LED
E27, 4 W
470 lm, 2.700 K



987-400



24



42

Wandleuchte · Wall lamp

excl. 1 x E27
max. 40 W

2023601**24**

2023601**42**

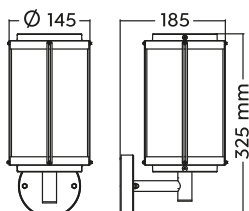

DUERO

Aluminium Druckguss, Glas · Diecast aluminium, glass ·
 Fonte d'aluminium, verre · Gegoten aluminium, glas ·
 Aluminio fundido, vidrio · Pressofusione di alluminio, vetro ·
 Fonta aluminiu, sticla · Valualumiini, lasi · Barwione aluminium, szkło

 **24** | rostfarbig · rusty

 **42** | Anthrazit · anthracite

Empfohlen:
recommended:

Filament LED
E27, 4 W
470 lm, 2.700 K



987-400



Wandleuchte · Wall lamp

excl. 1 x E27
max. 40 W

2027601**24**
2027601**42**

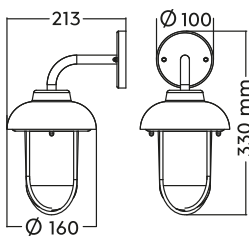

LUNGA

Aluminium Druckguss, Glas · Diecast aluminium, glass ·
 Fonte d'aluminium, verre · Gegoten aluminium, glas ·
 Aluminio fundido, vidrio · Pressofusione di alluminio, vetro ·
 Fonta aluminiu, sticla · Valualumiini, lasi · Barwione aluminium, szkło

 **42** | Anthrazit · anthracite



Dämmerungssensor per Schalter deaktivierbar ·
On and off switchable dusk sensor

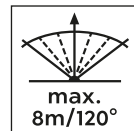

Wandleuchte · Wall lamp

excl. 1 x E27
max. 40 W

2120601**42**

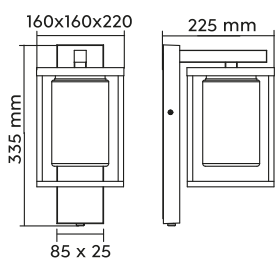

Wandleuchte · Wall lamp

excl. 1 x E27
max. 40 W

2120691**42**

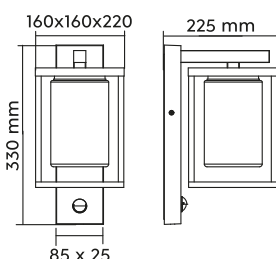

MIRANDE

Aluminium Druckguss, Glas · Diecast aluminium, glass ·
Fonte d'aluminium, verre · Gegoten aluminium, glas ·
Aluminio fundido, vidrio · Pressofusione di alluminio, vetro ·
Fonta aluminiu, sticla · Valualumiini, lasi · Barwione aluminium, szkło

 **24** | rostfarbig · rusty

 **42** | Anthrazit · anthracite

 **31** | Weiß matt · white mat

Empfohlen:
recommended:

Filament LED
E27, 4 W
470 lm, 2.700 K



987-400



Wandleuchte · Wall lamp

excl. 1 x E27
max. 40 W

262260124

262260131

262260142

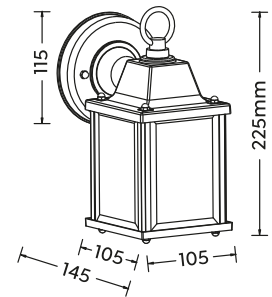

BELAJA

Edelstahl · Steel ·
Acier · Staal · Acero ·
Acciaio · Inox · Teräs · Stal



Abstrahlwinkel ·
Emission angle



Belastbarkeit ·
Resilience

07 | Nickel matt · nickel mat



Einbauleuchte · Recessed spot
incl. SMD-LED
3,5 W / 350 Lumen
3.000 Kelvin
821660107

IP65

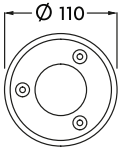
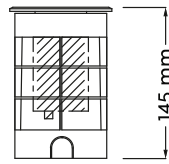

Einbauleuchte · Recessed spot
incl. SMD-LED
8 W / 900 Lumen
3.000 Kelvin
821660207

IP65

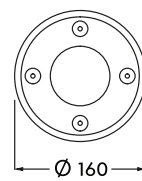
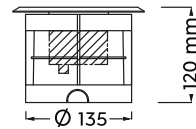

UBANGI

Aluminium Druckguss · Diecast aluminium ·
 Fonte d'aluminium · Gegoten aluminium · Aluminio fundido ·
 Pressofusione di alluminio · Fonta aluminiu · Valualumiini · Barwione aluminium

42 | Anthrazit · anthracite

Empfohlen:
 recommended:

LED GU10, 4,9 W
 430 lm, 3.000 K
 ≥ 110°



955-50



Strahler · Spot
 excl. 1 x GU10
 max. 10 W
800260142

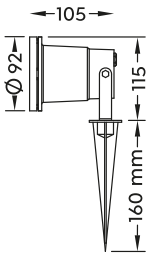

Strahler · Spot
 excl. 3 x GU10
 max. 10 W
800260342

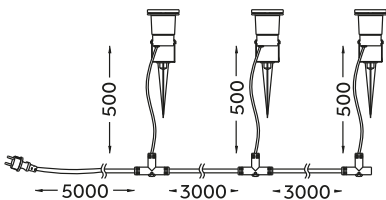

3er Set / Set 3



GARTENSTECKDOSEN · GARDEN SOCKETS

Aluminium Druckguss · Diecast aluminium ·
 Fonte d'aluminium · Gegoten aluminium · Aluminio fundido ·
 Pressofusione di alluminio · Fonta aluminii · Valualumiini · Barwione aluminium

 4 x Steckdosen ·
 4 x Plug

 42 | Anthrazit · anthracite



Gartensteckdose · Garden socket
 max. 3.600 W
 9964-42

   IP54

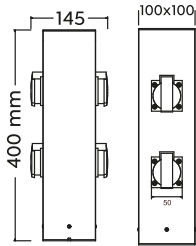

Polyresin · Polyresin ·
 Polyresin · Polyresin · Poliresina ·
 Poliestere · Polirasina · Polyresiini · Polyresin

 4 x Steckdosen ·
 4 x Plug

 11 | Grau · grey



Gartensteckdose · Garden socket
 max. 3.600 W
 9962-11

    IP44

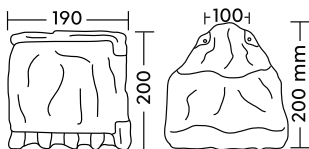

UNIVERSAL-ERDSPIESS · GROUND SPIKE

Erdspieß, Edelstahl · Ground spike, steel ·

Piquet de terre, acier · Aardingspin, staal · Espiga, acero ·

Picchetto, acciaio · Țepușă pentru pământ, inox · Maapiikki, teräs · Žerdz, stal

07 | Nickel matt · nickel mat



9960-07

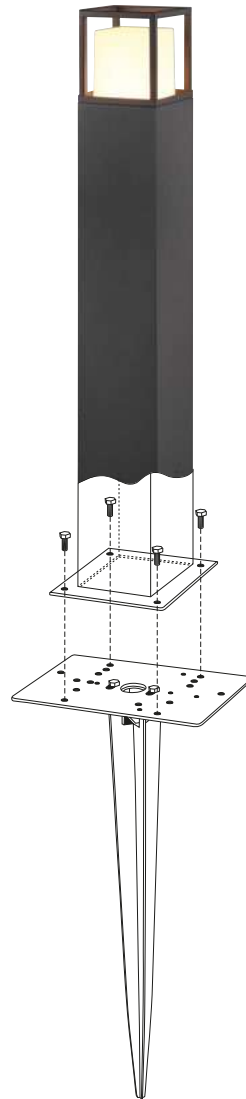
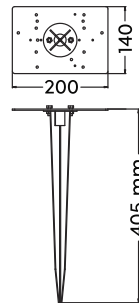

ECKBEFESTIGUNG · CORNER FASTENING

Eckbefestigung, Kunststoff · Corner fastening, plastic ·

Montage en angle, plastique · Hoekbevestiging, kunststof · Cantonera, plástico ·

Montaggio ad angolo, plastica · Fixare pentru colț, plastic · Kulmakiinnike, muovi · Okucie narożne, plastik

32 | Schwarz matt · black mat

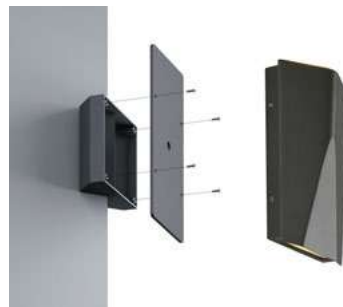

9965-32

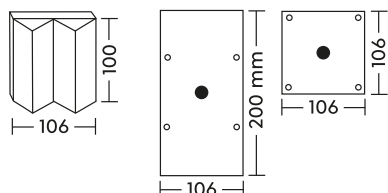





BEJA

Aluminium Druckguss, Kunststoff · Diecast aluminium, plastic ·
 Fonte d'aluminium, plastique · Gegoten aluminium, kunststof ·
 Aluminio fundido, plástico · Pressofusione di alluminio, plastica ·
 Fonta aluminiu, plastic · Valualumiini, muov · Barwione aluminium, plastik



Bewegungssensor ·
 Motion sensor

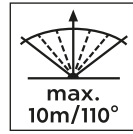

42 | Anthrazit · anthracite

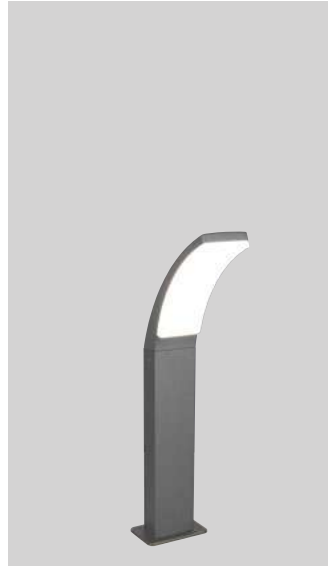

Wandleuchte · Wall lamp
 incl. SMD-LED
 12,5 W / 1.650 Lumen
 4.000 Kelvin
R23356142

Wandleuchte · Wall lamp
 incl. SMD-LED
 12,5 W / 1.650 Lumen
 4.000 Kelvin
R23359142

Sockelleuchte · Podestal lamp
 incl. SMD-LED
 12,5 W / 1.650 Lumen
 4.000 Kelvin
R53356142

Bodenleuchte · Floor lamp
 incl. SMD-LED
 12,5 W / 1.650 Lumen
 4.000 Kelvin
R43356142

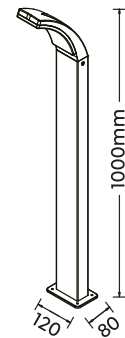
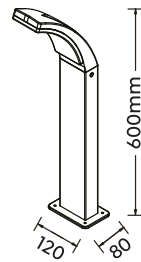
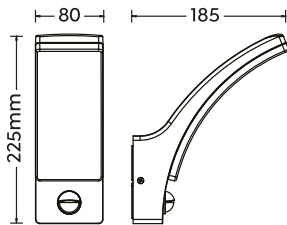
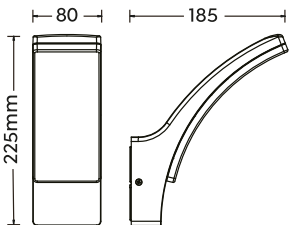



BRAGA

Metall, Glas · Metal, glass ·

Metale, verre · Metaal, glas · Metal, vidrio ·

Metallo, vetro · Metal, sticla · Metalli, lasi · Metal, szkło



31 | Weiß matt · white mat



32 | Schwarz matt · black mat

Empfohlen:
recommended:

LED GU10, 4,5 W
345 lm, 3.000 K
 $\approx 36^\circ$



956-5936



Wandleuchte · Wall lamp

excl. 1 x GU10

max. 10 W

R26971631

R26971632



IP44

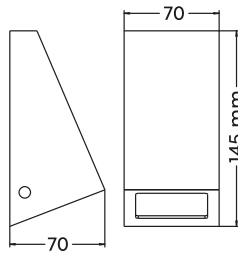

CUSCO

Kunststoff · Plastic ·
Plastique · Kunststof · Plástico ·
Plastica · Plastic · Muovi · Plastik

● 32 | Schwarz matt · black mat

Incl.:
LED GX53, 10 W
950 lm, 4.000 K



Wandleuchte · Wall lamp
incl. LED GX53
10 W / 950 Lumen
4.000 Kelvin
R26961632

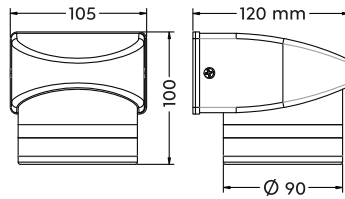

Wandleuchte · Wall lamp
incl. 2 x LED GX53
2 x 10 W / 2 x 950 Lumen
4.000 Kelvin
R26962632

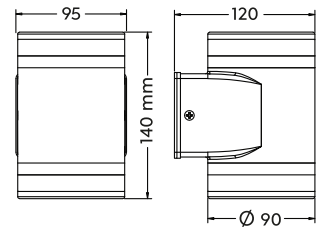

CORDOBA

Kunststoff · Plastic ·

Plastique · Kunststof · Plástico ·

Plastica · Plastic · Muovi · Plastik



31 | Weiß matt · white mat



32 | Schwarz matt · black mat



Wandleuchte · Wall lamp

incl. 2 x SMD-LED

2 x 2 W / 2 x 200 Lumen

3.000 Kelvin

R282226**31**

R282226**32**



IP44

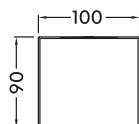
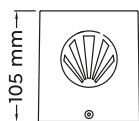

ROSARIO

Kunststoff · Plastic ·
Plastique · Kunststoff · Plástico ·
Plastica · Plastic · Muovi · Plastik

○ 31 | Weiß matt · white mat

● 32 | Schwarz matt · black mat



Wandleuchte · Wall lamp
incl. 2 x SMD-LED
2 x 2 W / 2 x 200 Lumen
3.000 Kelvin
R28232631
R28232632

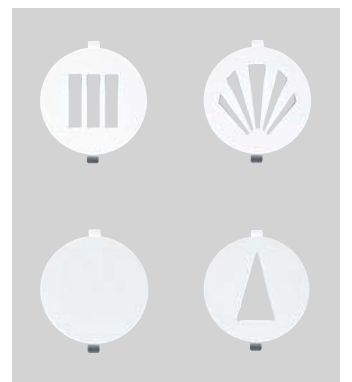
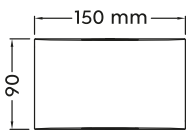
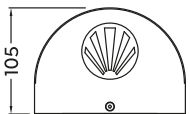

MOLINA

Aluminium Druckguss, Kunststoff · Diecast aluminium, plastic ·

Fonte d'aluminium, plastique · Gegoten aluminium, kunststof · Aluminio fundido, plástico ·

Pressofusione di alluminio, plastica · Fonta aluminii, plastic · Valualumiini, muovii · Barwione aluminium, plastik

42 | Anthrazit · anthracite



Wandleuchte · Wall lamp
incl. 2 x SMD-LED
2 x 4,6 W / 2 x 550 Lumen
3.000 Kelvin
R22052142

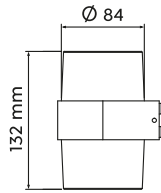
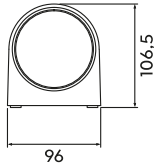

Wandleuchte · Wall lamp
incl. 2 x SMD-LED
2 x 4,6 W / 2 x 550 Lumen
3.000 Kelvin
R22062142

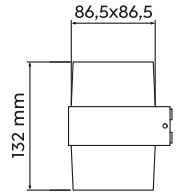
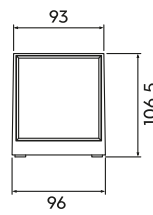

PUNO

Kunststoff · Plastic ·
Plastique · Kunststoff · Plástico ·
Plastica · Plastic · Muovi · Plastik

● 32 | Schwarz matt · black mat



Wandleuchte · Wall lamp
incl. SMD-LED
8 W / 800 Lumen
3.000 Kelvin
R27026132

IP54

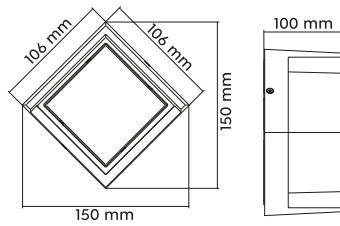

Wandleuchte · Wall lamp
incl. SMD-LED
8 W / 800 Lumen
3.000 Kelvin
R27036132

IP54

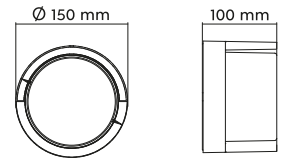

FORTALEZA

Aluminium Druckguss, Kunststoff · Diecast aluminium, plastic ·
 Fonte d'aluminium, plastique · Gegoten aluminium, kunststof ·
 Aluminio fundido, plástico · Pressofusione di alluminio, plastica ·
 Fonta aluminiu, plastic · Valualumiini, muovii · Barwione aluminium, plastik

● 42 | Anthrazit · anthracite

 Bewegungssensor und Orientierungslicht ·
 Motion sensor and orientation light

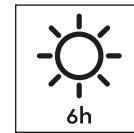
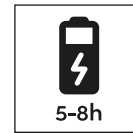
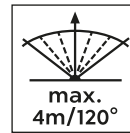

Wandleuchte · Wall lamp
 incl. SMD-LED
 2 W / 200 Lumen
 3.000 Kelvin
R23056142

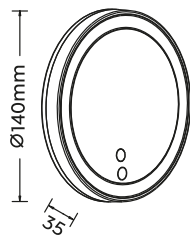

Wandleuchte · Wall lamp
 incl. SMD-LED
 2 W / 200 Lumen
 3.000 Kelvin
R23056242

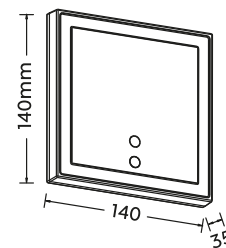

 **AKKUBETRIEB**
 RECHARGEABLE



AMBATO

Kunststoff · Plastic ·
Plastique · Kunststoff · Plástico · Plastica · Plastic · Muovi · Plastik



Stoßfest gemäß IK10 ·
Shock-resistant according to IK10

 **31** | Weiß matt · white mat

 **32** | Schwarz matt · black mat



31



32

Wandleuchte · Wall lamp
excl. 1 x E27
max. 10 W
R26931631
R26931632

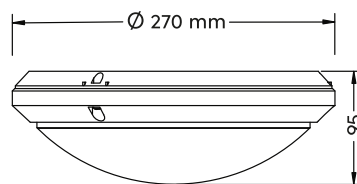

BARCELOS

Aluminium Druckguss, Kunststoff · Diecast aluminium, plastic ·
Fonte d'aluminium, plastique · Gegoten aluminium, kunststof ·
Aluminio fundido, plástico · Pressofusione di alluminio, plastica ·
Fonta aluminiu, plastic · Valualumiini, muovi · Barwione aluminium, plastik

 **32** | Schwarz matt · black mat



Wandleuchte · Wall lamp
excl. 2 x GU10
max. 10 W
R26446232

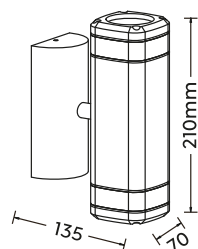

FUNCHAL

Aluminium Druckguss, Glas · Diecast aluminium, glass ·
 Fonte d'aluminium, verre · Gegoten aluminium, glas ·
 Aluminio fundido, vidrio · Pressofusione di alluminio, vetro ·
 Fonta aluminiu, sticla · Valualumiini, lasi · Barwione aluminium, szkło

● 32 | Schwarz matt · black mat

 Kippbar ·
Tilttable

 Bewegungssensor ·
Motion sensor

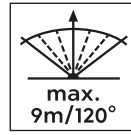

Wandleuchte · Wall lamp
 incl. SMD-LED
 20 W / 1.800 Lumen
 4.000 Kelvin
R23346132

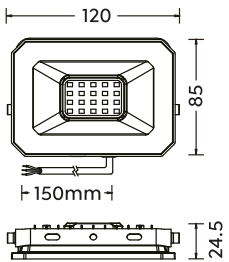

Wandleuchte · Wall lamp
 incl. SMD-LED
 30 W / 2.800 Lumen
 4.000 Kelvin
R23346232

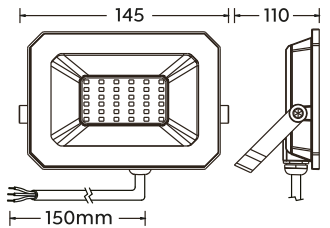

Wandleuchte · Wall lamp
 incl. SMD-LED
 20 W / 1.800 Lumen
 4.000 Kelvin
R23349132

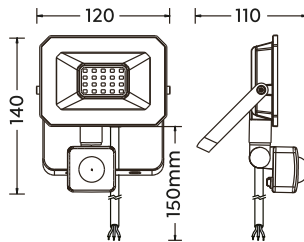

Wandleuchte · Wall lamp
 incl. SMD-LED
 30 W / 2800 Lumen
 4.000 Kelvin
R23349232

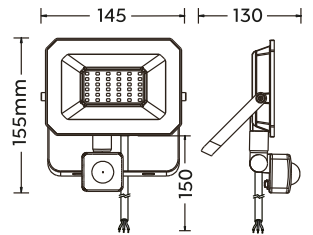



PUELO

Aluminium Druckguss, Kunststoff · Diecast aluminium, plastic ·
Fonte d'aluminium, plastique · Gegoten aluminium, kunststof ·
Aluminio fundido, plástico · Pressofusione di alluminio, plastica ·
Fonta aluminiu, plastic · Valualumiini, muovii · Barwione aluminium, plastik

○ 31 | Weiß matt · white mat

● 32 | Schwarz matt · black mat

Empfohlen:
recommended:

LED E27, 4,9 W
470 lm, 3.000 K



987-60



31



32

Wandleuchte · Wall lamp

excl. 1 x E27
max. 10 W

R21186131

R21186132

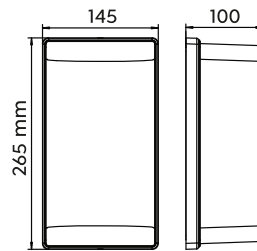

SINTRA

Edelstahl, Glas · Steel, glass ·
 Acier, verre · Staal, glas · Acero, vidrio ·
 Acciaio, vetro · Inox, sticla · Teräs, lasi · Stal, szkło

● 32 | Schwarz matt · black mat

 Bewegungssensor ·
 Motion sensor

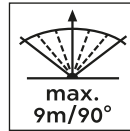

Empfohlen:
 recommended:

LED E27, 4,9 W
 470 lm, 3.000 K



987-60



Wandleuchte · Wall lamp
 excl. 1 x E27
 max. 25 W
R26456132

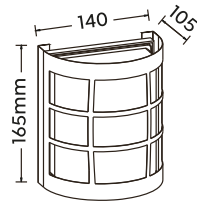

Wandleuchte · Wall lamp
 excl. 1 x E27
 max. 25 W
R26459132

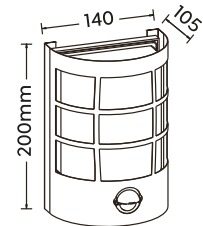

KENDAL

Kunststoff · Plastic ·
Plastique · Kunststof · Plástico ·
Plastica · Plastic · Muovi · Plastik

● 42 | Anthrazit · anthracite



Wandleuchte · Wall lamp
incl. SMD-LED
12 W / 1.400 Lumen
3.000 Kelvin
R22151142

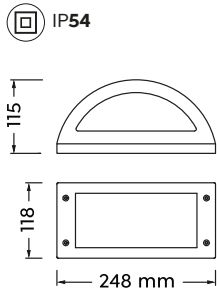

Deckenleuchte · Ceiling lamp
incl. SMD-LED
11 W / 1.180 Lumen
3.000 Kelvin
R62151142

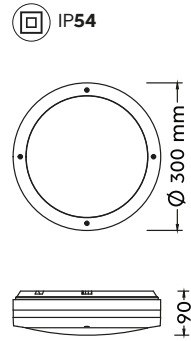

CAMARO

Kunststoff · Plastic ·
Plastique · Kunststof · Plástico ·
Plastica · Plastic · Muovi · Plastik

○ 31 | Weiß matt · white mat

● 42 | Anthrazit · anthracite

Empfohlen:
recommended:

LED E27, 4,9 W
470 lm, 3.000 K



986-60



31



42

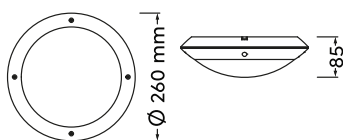

Deckenleuchte · Ceiling lamp
excl. 1 x E27
max. 12 W
R60501031
R60501042

● IP54





BONITO

Aluminium Druckguss, Kunststoff · Diecast aluminium, plastic ·
Fonte d'aluminium, plastique · Gegoten aluminium, kunststof ·
Aluminio fundido, plástico · Pressofusione di alluminio, plastica ·
Fonta aluminiu, plastic · Valualumiini, muovii · Barwione aluminium, plastik

● 24 | rostfarbig · rusty

● 32 | Schwarz matt · black mat

○ 31 | Weiß matt · white mat

Empfohlen:
recommended:

Filament LED
E27, 4 W
470 lm, 2.700 K



987-400



24



31



32

Wandleuchte · Wall lamp

excl. 1 x E27

max. 28 W

R21596124

R21596131

R21596132



IP44

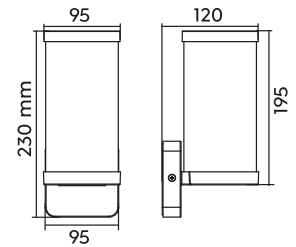

ALMERIA

Aluminium Druckguss, Kunststoff · Diecast aluminium, plastic ·
Fonte d'aluminium, plastique · Gegoten aluminium, kunststof ·
Aluminio fundido, plástico · Pressofusione di alluminio, plastica ·
Fonta aluminiu, plastic · Valualumiini, muovu · Barwione aluminium, plastik

 **24** | rostfarbig · rusty

 **42** | Anthrazit · anthracite

Empfohlen:
recommended:

Filament LED
E27, 4 W
470 lm, 2.700 K



987-400



Wandleuchte · Wall lamp

excl. 1 x E27

max. 28 W

R264761**24**

R264761**42**

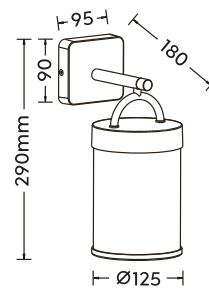

SCOOP

Edelstahl · Steel ·
Acier · Staal · Acero ·
Acciaio · Inox · Teräs · Stal

32 | Schwarz matt · black mat

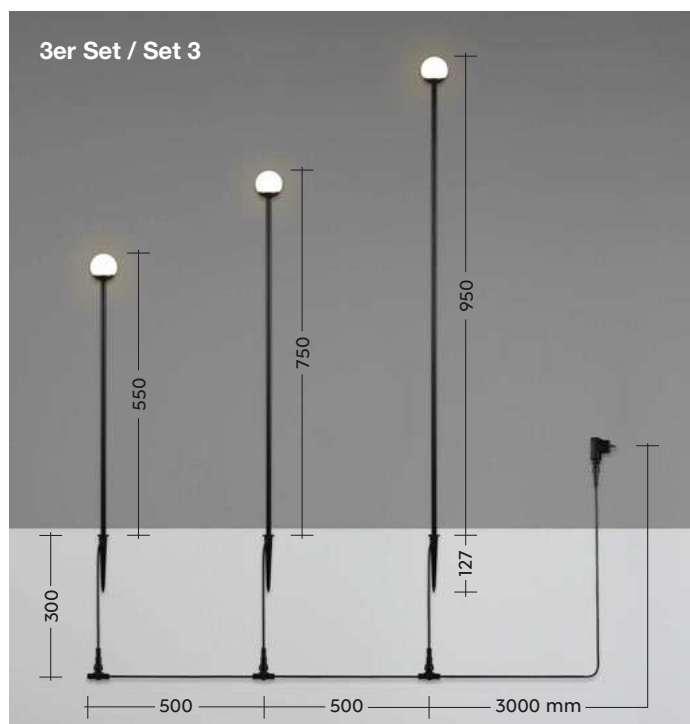

Gartenleuchte · Garden lamp
incl. 3 x LED
3 x 1,5 W / 3 x 160 Lumen
3.000 Kelvin
R45863632

IP44



In der Höhe anpassbar (55 / 75 / 95 cm)
Height adjustable (55 / 75 / 95 cm)

STICK

Edelstahl · Steel ·
Acier · Staal · Acero ·
Acciaio · Inox · Teräs · Stal

32 | Schwarz matt · black mat



Gartenleuchte · Garden lamp
incl. 3 x LED
3 x 3,5 W / 3 x 330 Lumen
3.000 Kelvin
R45853632

IP44



In der Höhe anpassbar (55 / 75 / 95 cm)
Height adjustable (55 / 75 / 95 cm)

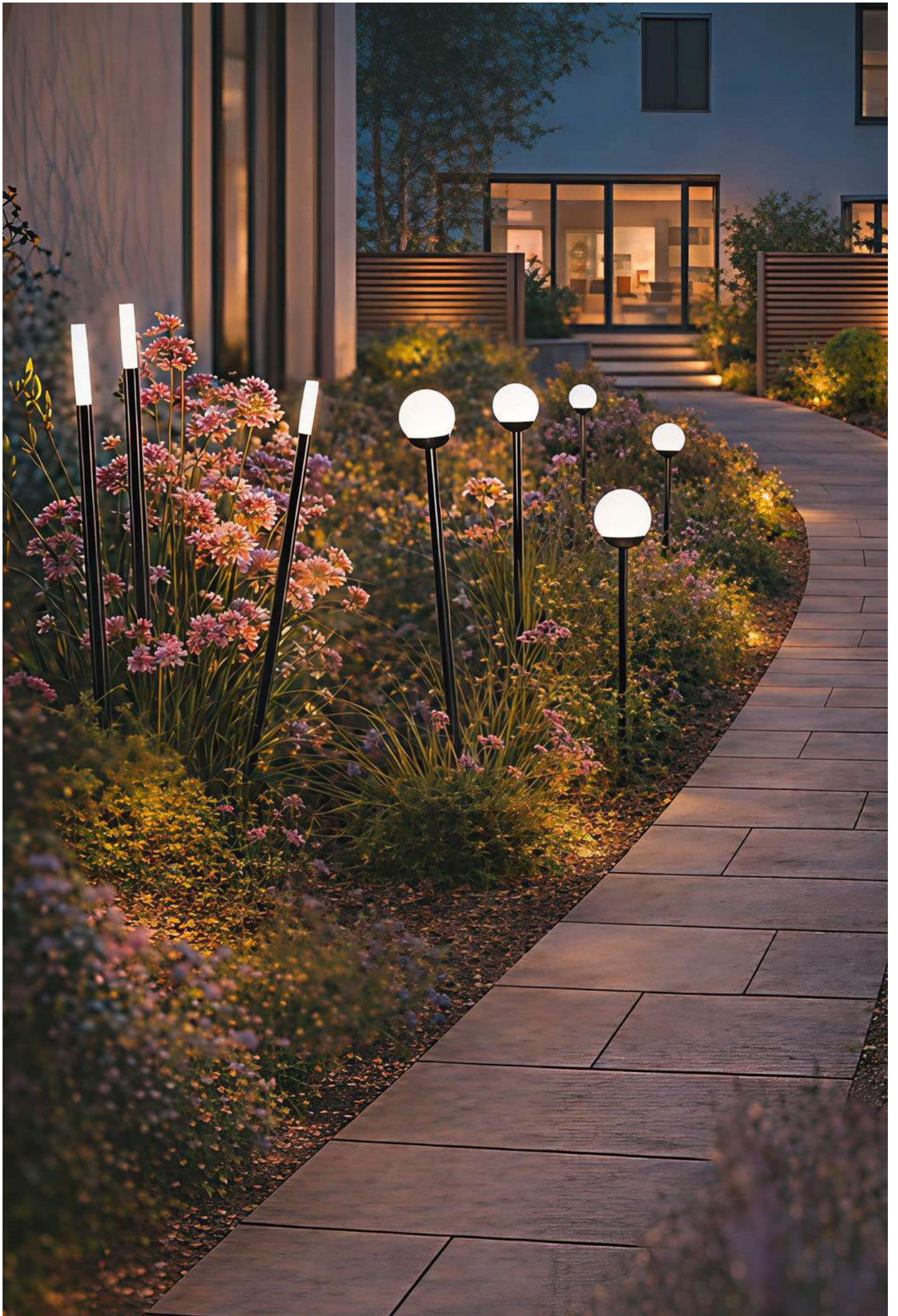

BOLO

Kunststoff · Plastic ·
Plastique · Kunststoff · Plástico ·
Plastica · Plastic · Muovi · Plastik

01 | Weiß · white

Empfohlen:
recommended:

LED E27, 4,9 W
470 lm, 3.000 K



987-60



Bodenleuchte · Floor lamp
excl. 1 x E27
max. 23 W
R57042001

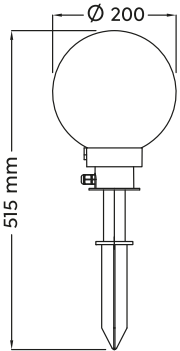

Bodenleuchte · Floor lamp
excl. 1 x E27
max. 23 W
R57043001

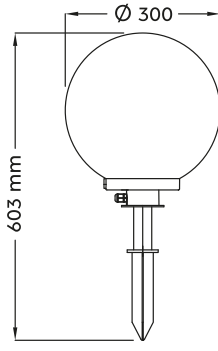

Bodenleuchte · Floor lamp
excl. 1 x E27
max. 23 W
R57044001

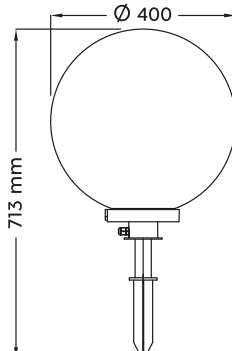

CACERES

Kunststoff · Plastic ·
Plastique · Kunststoff · Plástico ·
Plastica · Plastic · Muovi · Plastik

02 | Schwarz · black



Kippbar ·
Tilttable

Incl.:

LED E27, 15 W
1.500 lm, 4.000 K



Strahler · Spot
incl. LED E27
15 W / 1.500 Lumen
4.000 Kelvin
R86466102

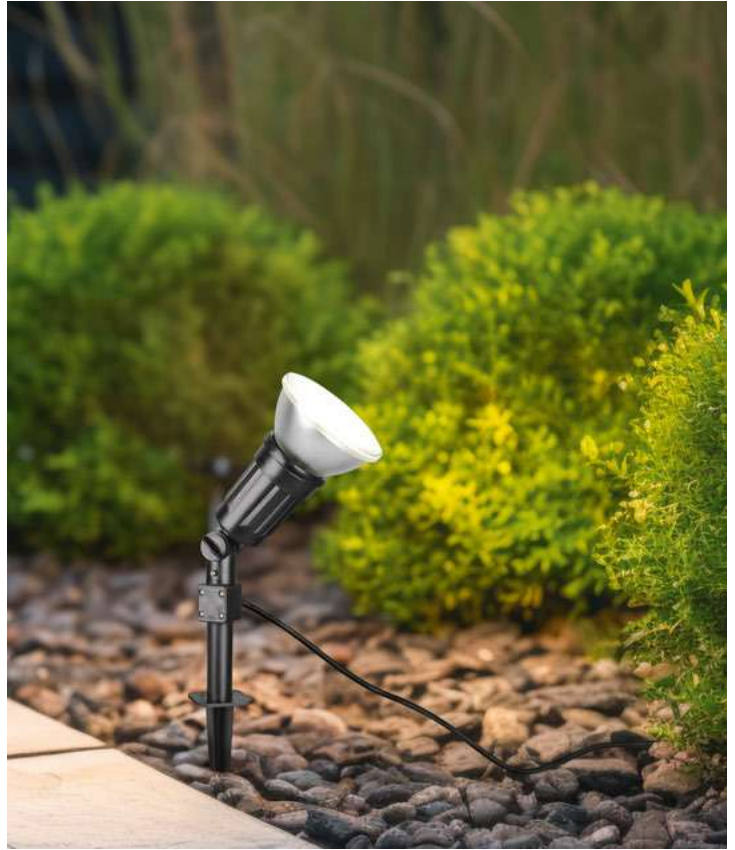
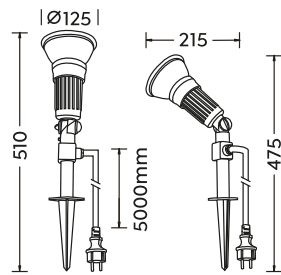

PURUS



Aluminium Druckguss · Diecast aluminium ·
Fonte d'aluminium · Gegoten aluminium · Aluminio fundido ·
Pressofusione di alluminio · Fonta aluminu · Valualumiini · Barwione aluminium

42 | Anthrazit · anthracite

Empfohlen:
recommended:

LED Mini-GU10
4 W, 345 lm
2.700 K



954-1432



Strahler · Spot
excl. 1 x GU10
max. 5 W
R86871042

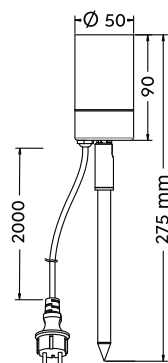

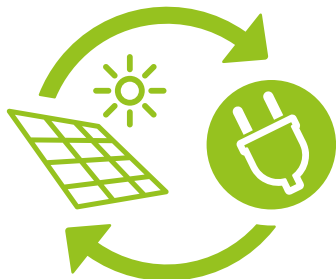

GB

Hybrid solar lights charge up with solar energy during the day and provide bright light at night. On cloudy days, when the sun is not shining and the solar charge is running low, the light automatically connects to the power grid to continue working at full capacity.

NL

Hybride solarlampen laden overdag op met zonne-energie en geven 's nachts helder licht. Op bewolkte dagen, als de zon niet schijnt en de zonnelading laag is, maakt de lamp automatisch verbinding met het elektriciteitsnet om op volle capaciteit te blijven werken.

IT

Le lampade solari ibride si ricaricano con l'energia solare durante il giorno e forniscono una luce brillante di notte. Nelle giornate nuvolose, quando il sole non splende e la carica solare è bassa, la lampada si collega automaticamente alla rete elettrica per continuare a funzionare a pieno regime.

FI

Hybridiaurinkolamput latautuvat aurinkoenergialla päivällä ja antavat loistavaa valoa yöllä. Pilvisenä päivänä, kun aurinko ei paista ja aurinkolataus on vähissä, lamppu kytkeytyy automaattisesti verkkoon jatkaakseen toimintaansa täydellä teholla.

D

Hybride Solarleuchten tanken tagsüber Sonnenenergie und sorgen nachts für helles Licht. An trüben Tagen, wenn die Sonne mal nicht scheint und die Solarladung zur Neige geht, verbindet sich die Leuchte automatisch mit dem Stromnetz, um mit voller Kapazität weiterzuarbeiten.

FR

Les lampes solaires hybrides se rechargent à l'énergie solaire pendant la journée et fournissent une lumière brillante la nuit. Par temps nuageux, lorsque le soleil ne brille pas et que la charge solaire est faible, la lampe se connecte automatiquement au réseau électrique pour continuer à fonctionner à pleine capacité.

ES

Las lámparas solares híbridas se recargan con energía solar durante el día y proporcionan una luz brillante por la noche. En los días nublados, cuando el sol no brilla y la carga solar es baja, la lámpara se conecta automáticamente a la red para seguir funcionando a pleno rendimiento.

RO

Lămpile solare hibride se reîncarcă cu energie solară în timpul zilei și oferă lumină strălucitoare noaptea. În zilele înnorate, când soarele nu strălucește și încărcarea solară este scăzută, lampa se conectează automat la rețea pentru a continua să funcționeze la capacitate maximă.

PL

Hybrydowe lampy solarne ładują się energią słoneczną w ciągu dnia i zapewniają doskonałe światło w nocy. W pochmurne dni, gdy słońce nie świeci, a poziom naładowania jest niski, lampa automatycznie łączy się z siecią, aby kontynuować pracę z pełną wydajnością.

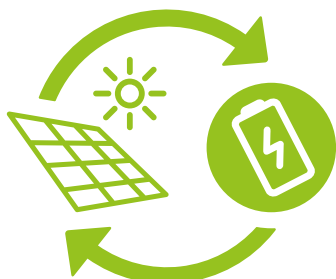

GB

If the solar charge is low, the light can be easily recharged in just a few hours using the built-in USB function. This guarantees constant light output and maximum efficiency.

NL

Als de zonne-energie bijna leeg is, kan de lamp eenvoudig in een paar uur worden opgeladen met de ingebouwde USB-functie. Dit garandeert een constante lichtopbrengst en maximale efficiëntie.

IT

Se la carica solare è bassa, la luce può essere facilmente ricaricata in poche ore utilizzando la funzione USB integrata. Questo garantisce un'emissione luminosa costante e la massima efficienza.

FI

Jos aurinkolataus on vähissä, valo voidaan ladata helposti muutamassa tunnissa sisäänrakennetun USB-toiminnon avulla. Tämä takaa tasaisen valotehon ja maksimaalisen tehokkuuden.

D

Bei schwacher Solarladung lässt sich die Leuchte in wenigen Stunden über die eingebaute USB-Funktion mühelos aufladen. Das garantiert konstante Lichtleistung und maximale Effizienz.

FR

Si la charge solaire est faible, la lampe peut être facilement rechargée en quelques heures grâce à la fonction USB intégrée. Cela garantit une luminosité constante et une efficacité maximale.

ES

Si la carga solar es baja, la luz puede recargarse fácilmente en unas pocas horas mediante la función USB incorporada. Esto garantiza una potencia luminosa constante y la máxima eficiencia.

RO

Dacă încărcarea solară este scăzută, lumina poate fi ușor reîncărată în doar câteva ore utilizând funcția USB încorporată. Acest lucru garantează o ieșire constantă a luminii și o eficiență maximă.

PL

Jeśli poziom naładowania baterii słonecznej jest niski, lampę można łatwo naładować w ciągu zaledwie kilku godzin za pomocą wbudowanej funkcji USB. Gwarantuje to stały strumień światła i maksymalną wydajność.

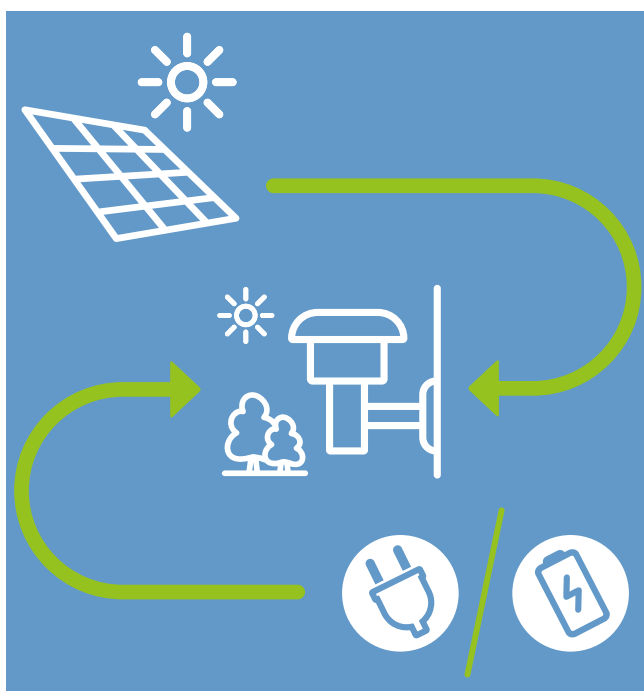

- ✓ 100% Stromkostensparnis während des Solar-Betriebs
- ✓ Sehr hohe Leuchtkraft bis zu 1.000 Lumen
- ✓ Hocheffiziente Solarmodule
- ✓ Bewegungsmelder und Dämmerungssensoren sorgen für eine effiziente Nutzung des Solarstroms und mehr Sicherheit
- ✓ 100% electricity cost savings during solar operation
- ✓ Very high luminosity up to 1,000 lumens
- ✓ Highly efficient solar modules
- ✓ Motion detectors and twilight sensors ensure efficient use of solar power and more safety

BLYDE

Aluminium Druckguss · Diecast aluminium ·
 Fonte d'aluminium · Gegoten aluminium · Aluminio fundido ·
 Pressofusione di alluminio · Fonta aluminii · Valualumiini ·
 Barwione aluminium

● 42 | Anthrazit · anthracite

 Bewegungssensor ·
 Motion sensor

 max.
 6m/120°

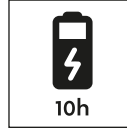
 10h

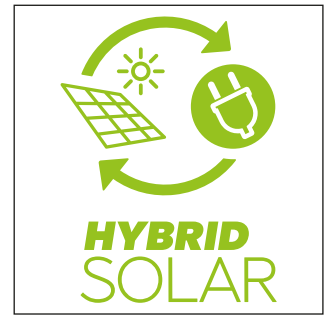

Sockelleuchte · Podestal lamp
 incl. SMD-LED
 5 W / 700 Lumen
 2.300 - 4.000 Kelvin
553569142



 IP65

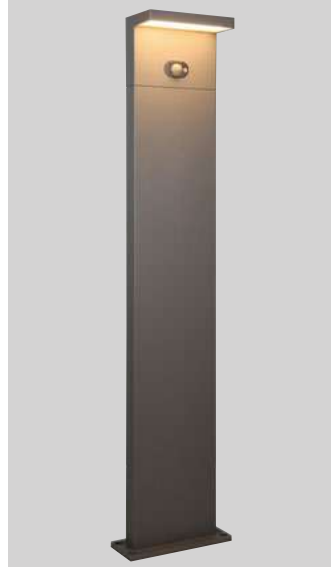
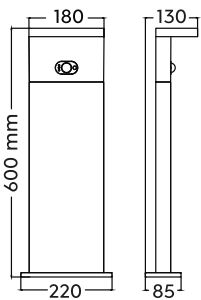

Bodenleuchte · Floor lamp
 incl. SMD-LED
 5 W / 700 Lumen
 2.300 - 4.000 Kelvin
453569142



 IP65

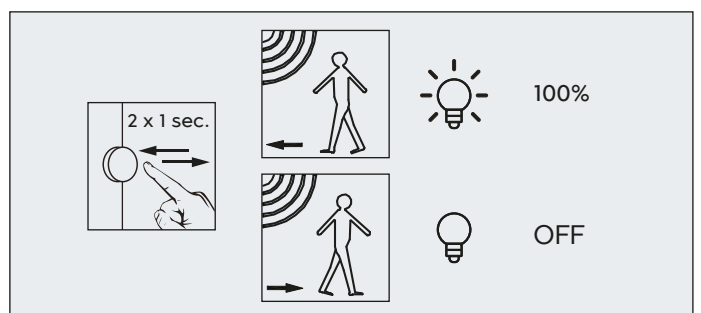
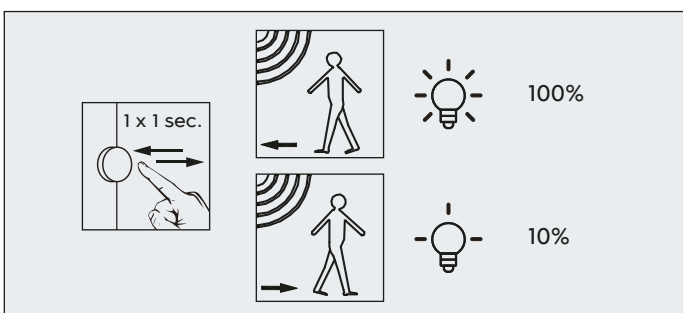
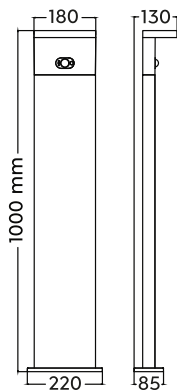





Wandleuchte · Wall lamp
 incl. SMD-LED
 5 W / 700 Lumen
 2.300 - 4.000 Kelvin
 253569142

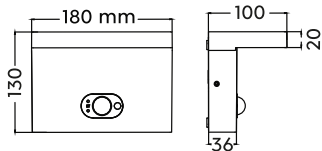

IP65



 Bewegungssensor · Motion sensor

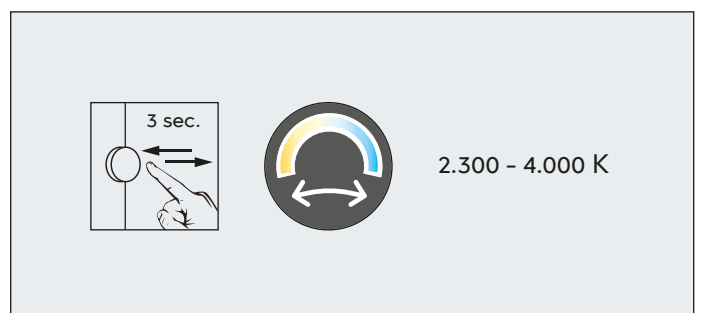
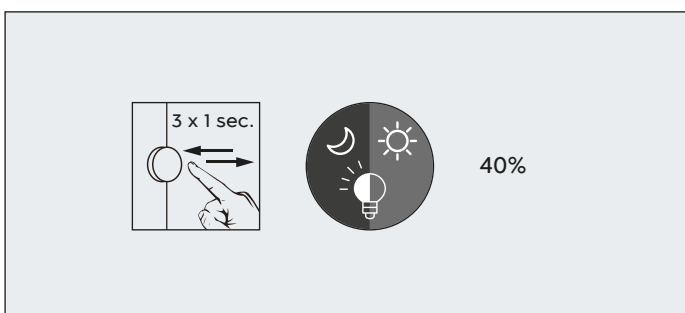
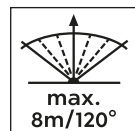

MALAWI

Aluminium Druckguss · Diecast aluminium ·
 Fonte d'aluminium · Gegoten aluminium · Aluminio fundido ·
 Pressofusione di alluminio · Fonta aluminii · Valualumiini ·
 Barwione aluminium



Bewegungssensor ·
 Motion sensor

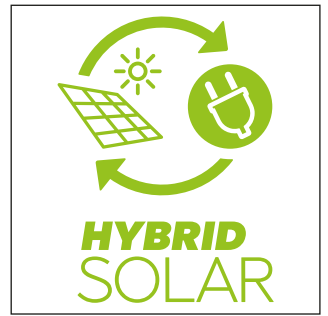
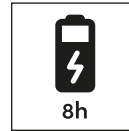
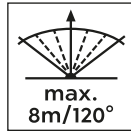

42 | Anthrazit · anthracite



Wandleuchte · Wall lamp
 incl. SMD-LED
 5 W / 700 Lumen
 2.300 - 4.000 Kelvin
253769142

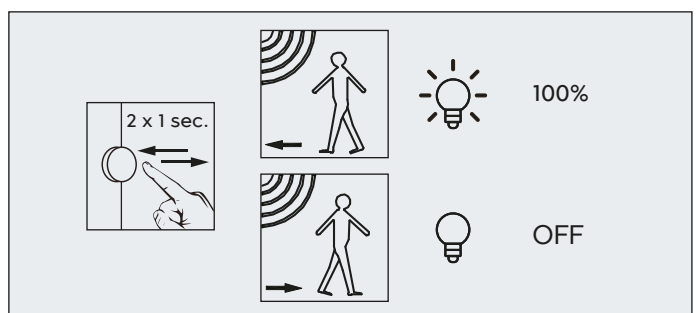
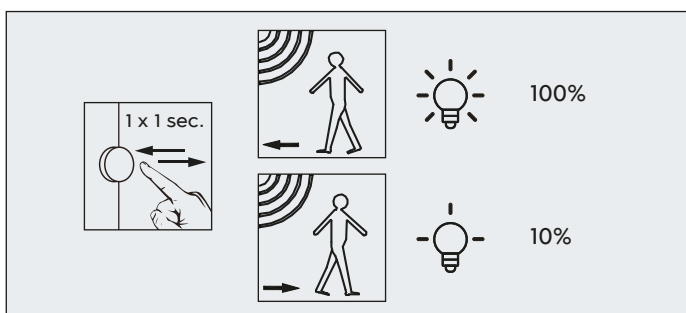
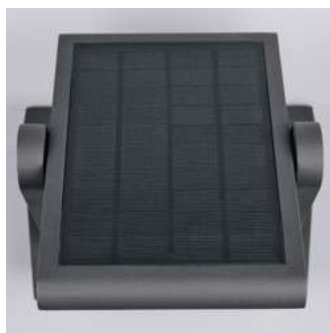
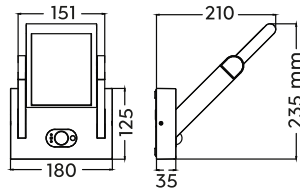



Sockelleuchte · Podestal lamp

incl. SMD-LED
5 W / 700 Lumen
2.300 - 4.000 Kelvin

553769142



IP65

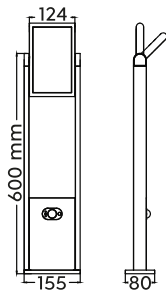

 Bewegungssensor ·
Motion sensor

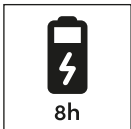

Bodenleuchte · Floor lamp

incl. SMD-LED
5 W / 700 Lumen
2.300 - 4.000 Kelvin

453769142



IP65

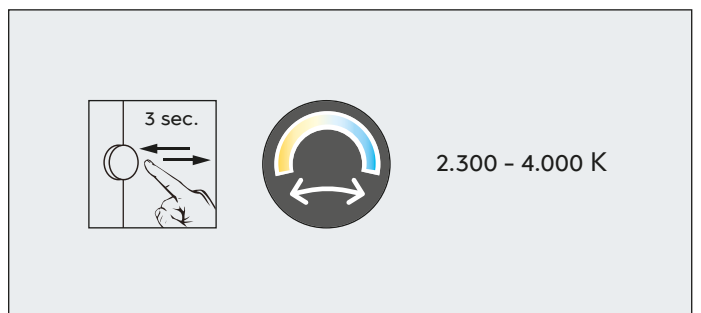
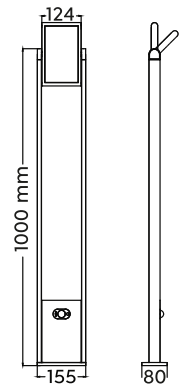

COLOMBO

Metall, Kunststoff · Metal, plastic ·
 Metale, plastique · Metaal, kunststof ·
 Metal, plástico · Metallo, plastica ·
 Metal, plastic · Metalli, muovi · Metal, plastik

● 32 | Schwarz matt · black mat



Bewegungssensor und Orientierungslicht ·
 Motion sensor and orientation light

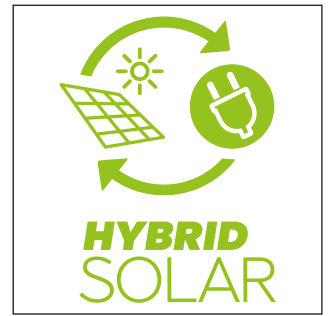
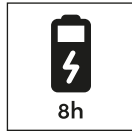
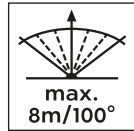

Wandleuchte · Wall lamp
 incl. SMD-LED
 5,5 W / 650 Lumen
 4.000 Kelvin
R23286132

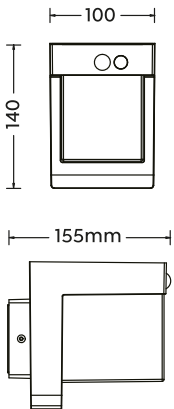

Sockelleuchte · Podestal lamp
 incl. SMD-LED
 5,5 W / 650 Lumen
 4.000 Kelvin
R53286132

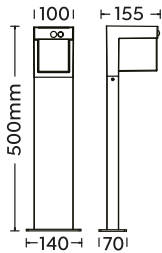

Bodenleuchte · Floor lamp
 incl. SMD-LED
 5,5 W / 650 Lumen
 4.000 Kelvin
R43286132

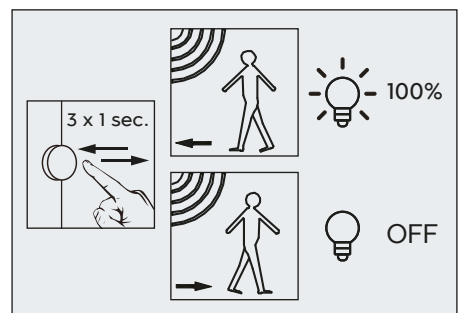
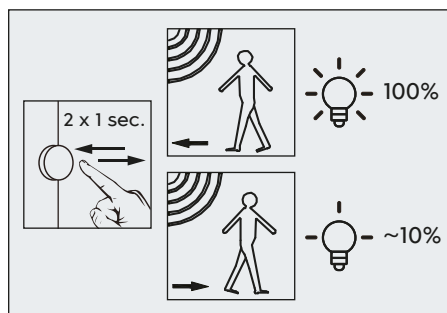
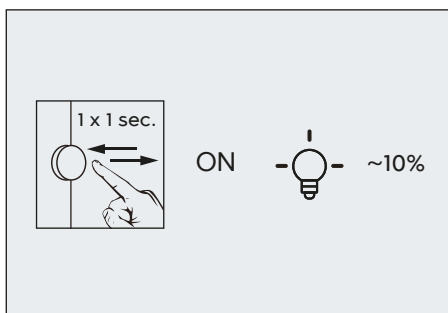
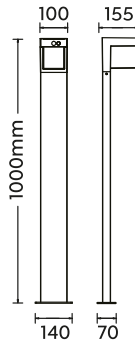





GORDA

Kunststoff · Plastic ·
Plastique · Kunststoff · Plástico ·
Plastica · Plastic · Muovi · Plastik

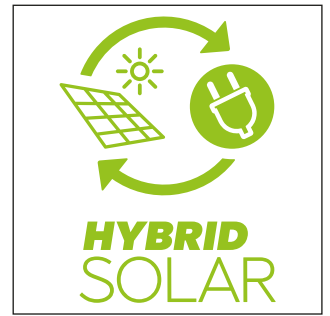
 Bewegungssensor ·
Motion sensor



 32 | Schwarz matt · black mat

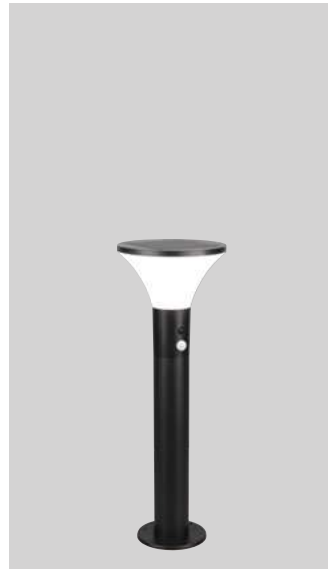
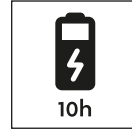
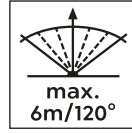
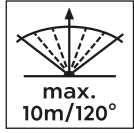

Wandleuchte · Wall lamp
incl. SMD-LED
3,5 W / 500 Lumen
4.000 Kelvin
R24676132

Sockelleuchte · Podestal lamp
incl. SMD-LED
3,5 W / 500 Lumen
4.000 Kelvin
R54676132

Bodenleuchte · Floor lamp
incl. SMD-LED
3,5 W / 500 Lumen
4.000 Kelvin
R44676132

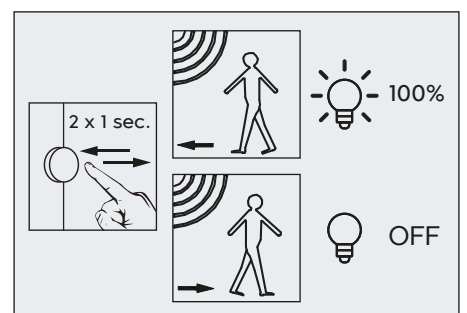
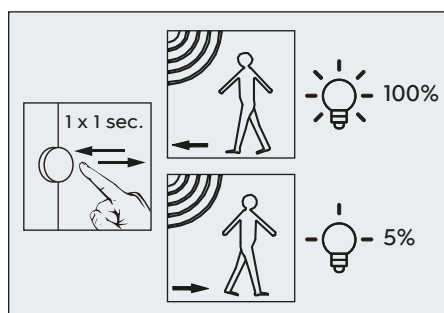
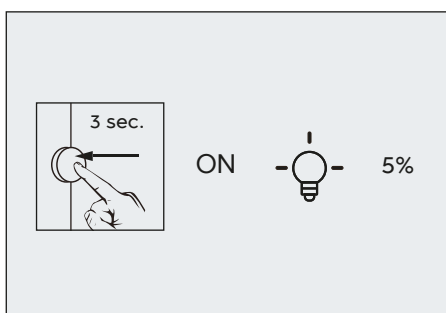
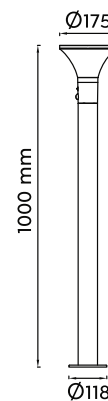
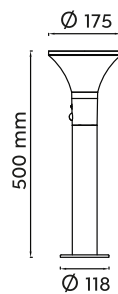
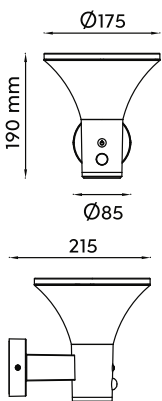



SILVES

Kunststoff · Plastic ·
Plastique · Kunststof · Plástico ·
Plastica · Plastic · Muovi · Plastik

○ 01 | Weiß · white

● 02 | Schwarz · black



Bewegungssensor und Orientierungslicht ·
Motion sensor and orientation light

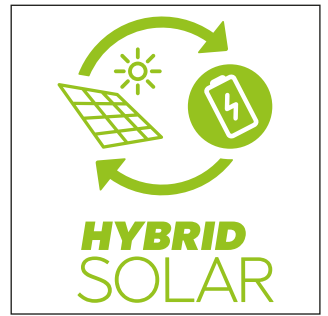
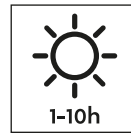
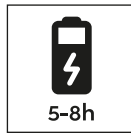
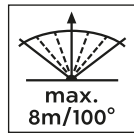

Wandleuchte · Wall lamp

incl. SMD-LED
6 W / 700 Lumen
4.000 Kelvin

R23306101
R23306102

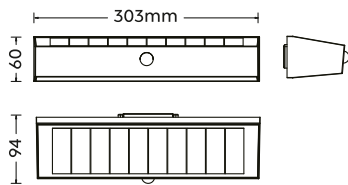

3 Helligkeitsstufen: 100%, 50%, 25%
3 brightness level: 100%, 50%, 25%

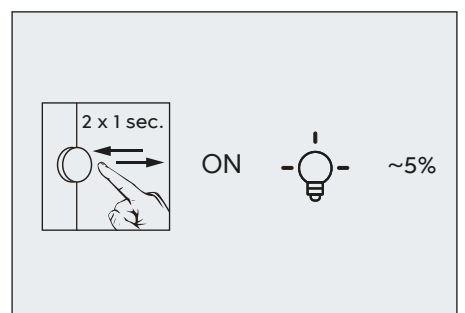
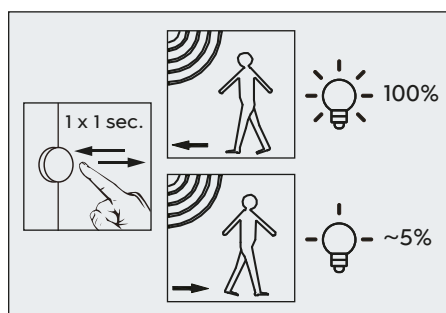
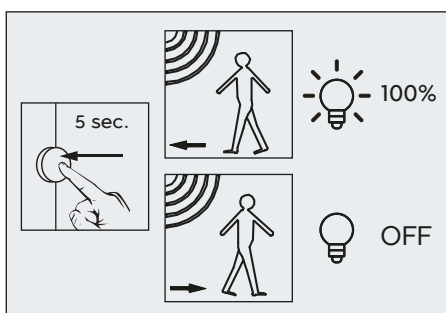
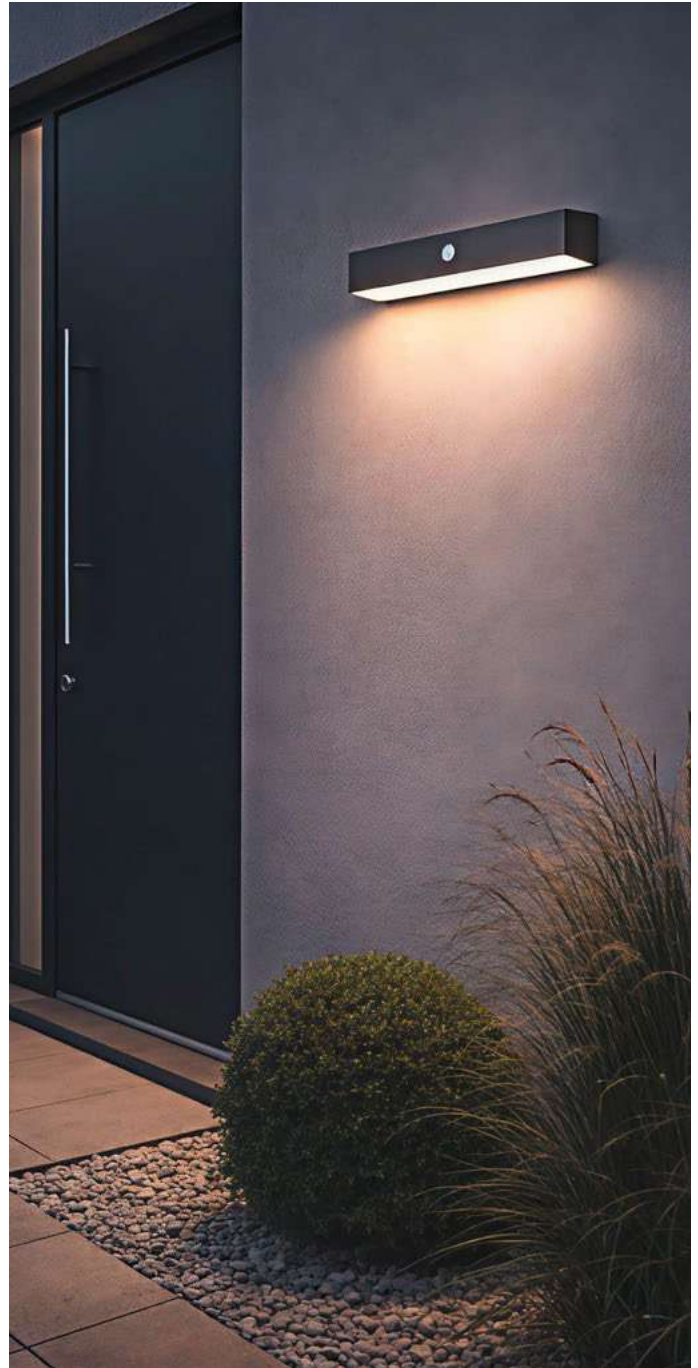

BILBAO

Kunststoff · Plastic ·
Plastique · Kunststoff · Plástico ·
Plastica · Plastic · Muovi · Plastik

○ 01 | Weiß · white

● 02 | Schwarz · black



Bewegungssensor und Orientierungslicht ·
Motion sensor and orientation light

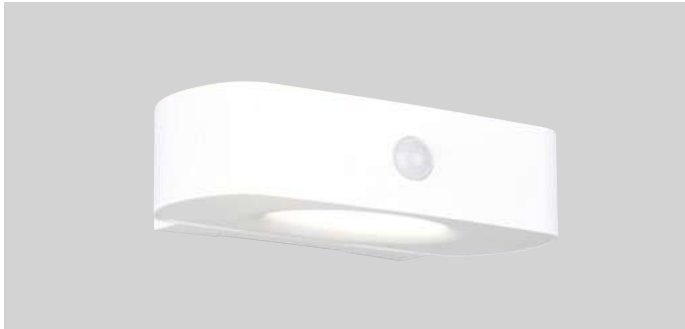
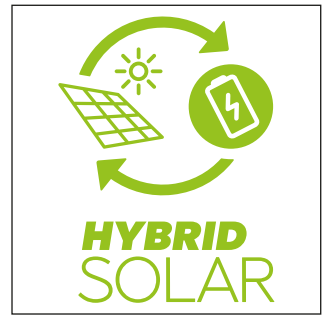
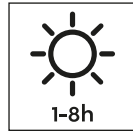
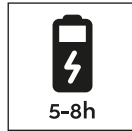
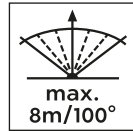

Wandleuchte · Wall lamp

incl. SMD-LED
6 W / 700 Lumen
4.000 Kelvin

R23336201
R23336202

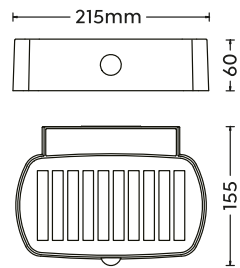

3 Helligkeitsstufen: 100%, 50%, 25%
3 brightness level: 100%, 50%, 25%

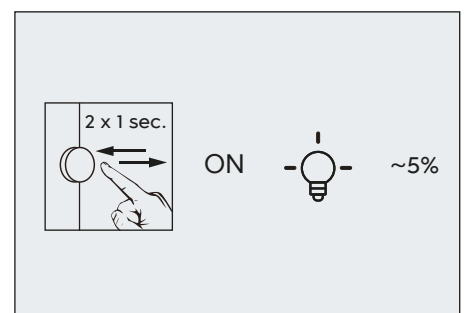
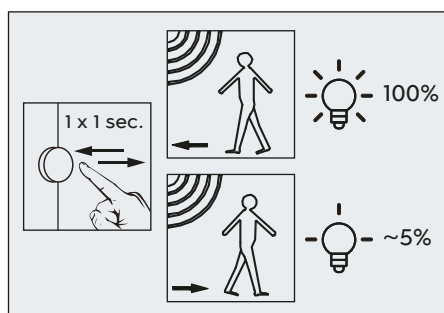
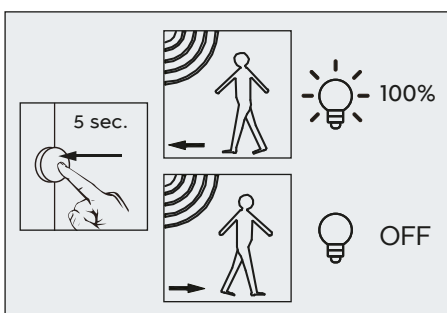

MORO

Kunststoff · Plastic ·
Plastique · Kunststoff · Plástico ·
Plastica · Plastic · Muovi · Plastik

● 32 | Schwarz matt · black mat



Bewegungssensor und Orientierungslicht ·
Motion sensor and orientation light

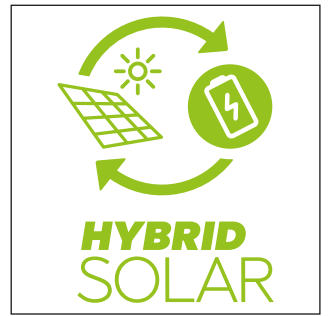
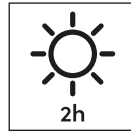
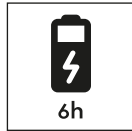
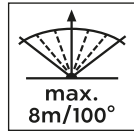

Wandleuchte · Wall lamp

incl. SMD-LED
8 W / 850 Lumen
4.000 Kelvin
R24706132

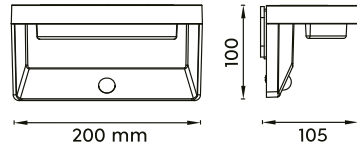

3 Helligkeitsstufen: 100%, 50%, 25%
3 brightness level: 100%, 50%, 25%

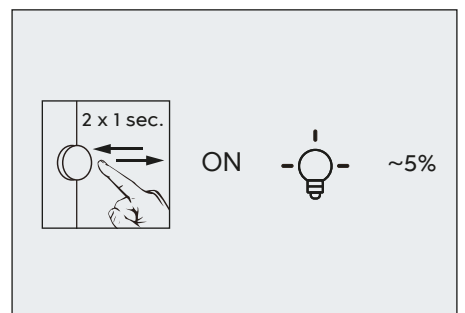
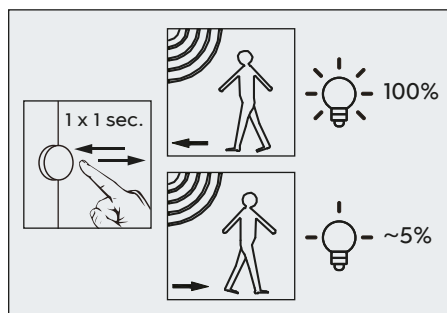
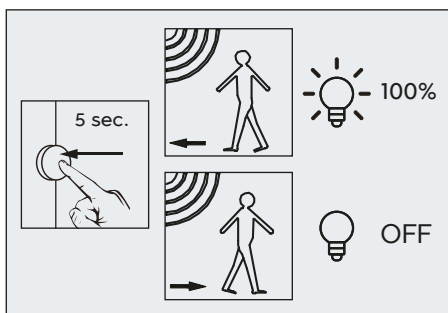

COBRE

Kunststoff · Plastic ·
Plastique · Kunststof · Plástico ·
Plastica · Plastic · Muovi · Plastik

● 32 | Schwarz matt · black mat

 Bewegungssensor und Orientierungslicht ·
Motion sensor and orientation light

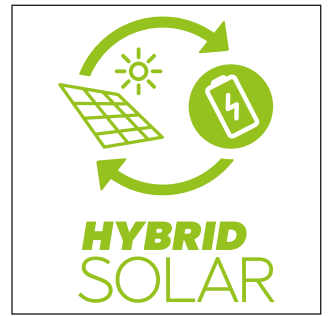
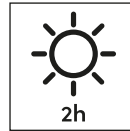
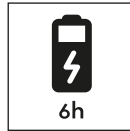
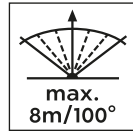

Wandleuchte · Wall lamp
incl. SMD-LED
8 W / 850 Lumen
4.000 Kelvin
R24716132

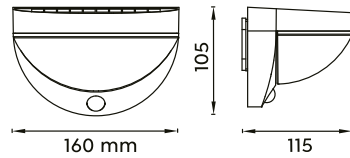

3 Helligkeitsstufen: 100%, 50%, 25%
3 brightness level: 100%, 50%, 25%

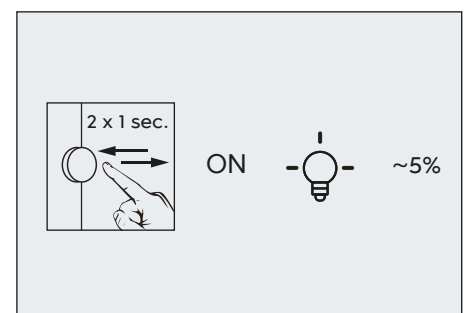
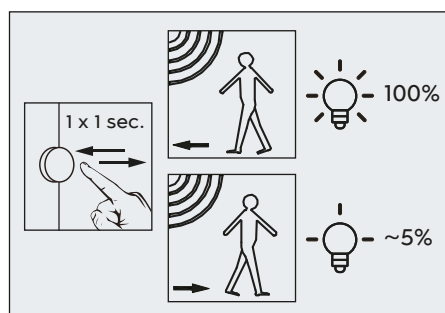
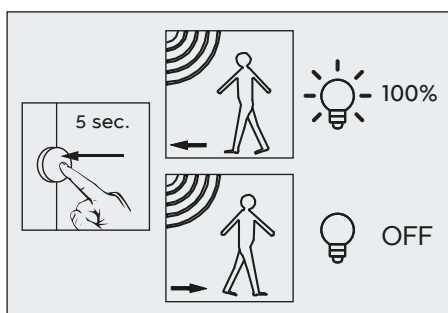

ALVORADA

Kunststoff · Plastic ·
Plastique · Kunststoff · Plástico ·
Plastica · Plastic · Muovi · Plastik

● 02 | Schwarz · black

 Bewegungssensor und Orientierungslicht ·
Motion sensor and orientation light

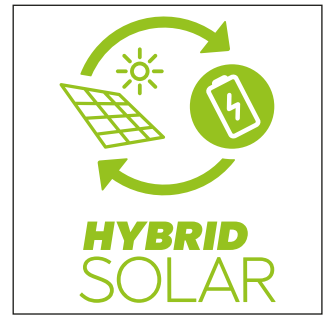
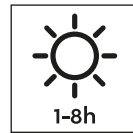
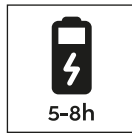
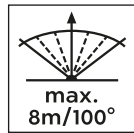

Wandleuchte · Wall lamp

incl. SMD-LED
6 W / 600 Lumen
4.000 Kelvin
R23326102

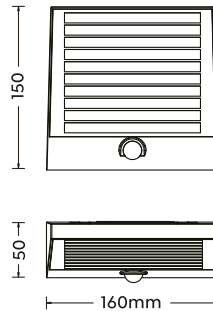

3 Helligkeitsstufen: 100%, 50%, 25%
3 brightness level: 100%, 50%, 25%

RAMOS

Kunststoff · Plastic ·
Plastique · Kunststoff · Plástico ·
Plastica · Plastic · Muovi · Plastik

● 32 | Schwarz matt · black mat

 Bewegungssensor und Orientierungslicht ·
Motion sensor and orientation light

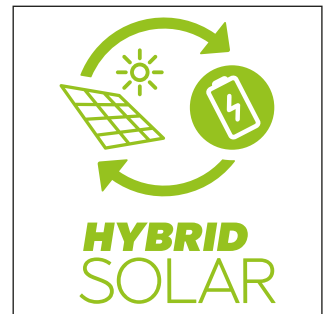
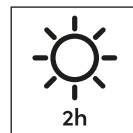
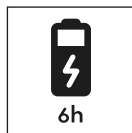
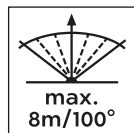

Wandleuchte · Wall lamp

incl. SMD-LED
8 W / 850 Lumen
4.000 Kelvin
R24746232

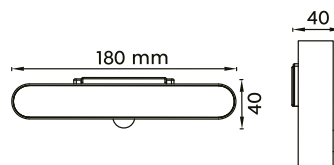

3 Helligkeitsstufen: 100%, 50%, 25%
3 brightness level: 100%, 50%, 25%

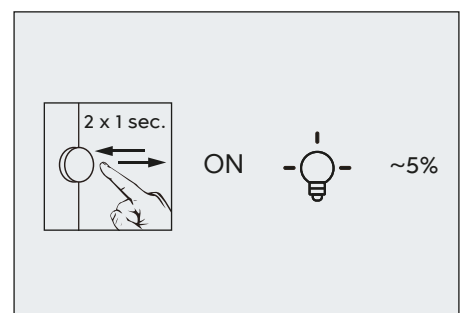
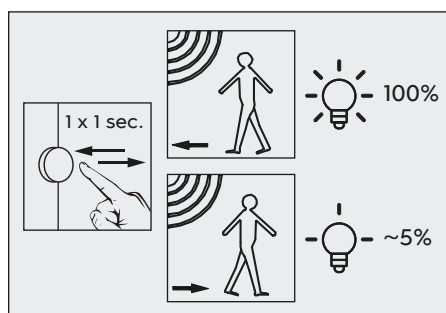
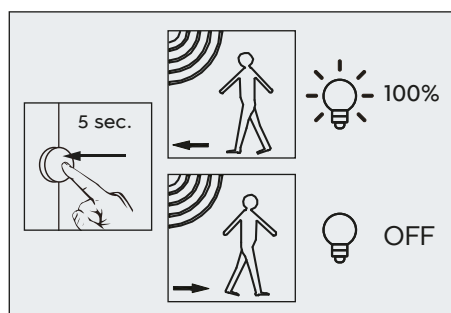

ATICO

Kunststoff · Plastic ·
Plastique · Kunststof · Plástico ·
Plastica · Plastic · Muovi · Plastik

● 32 | Schwarz matt · black mat



Bewegungssensor und Orientierungslicht ·
Motion sensor and orientation light

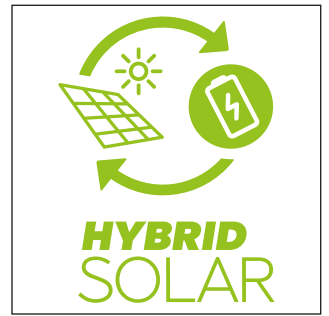
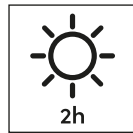
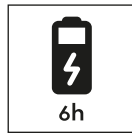
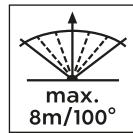

Wandleuchte · Wall lamp
incl. SMD-LED
8 W / 850 Lumen
4.000 Kelvin
R24696132

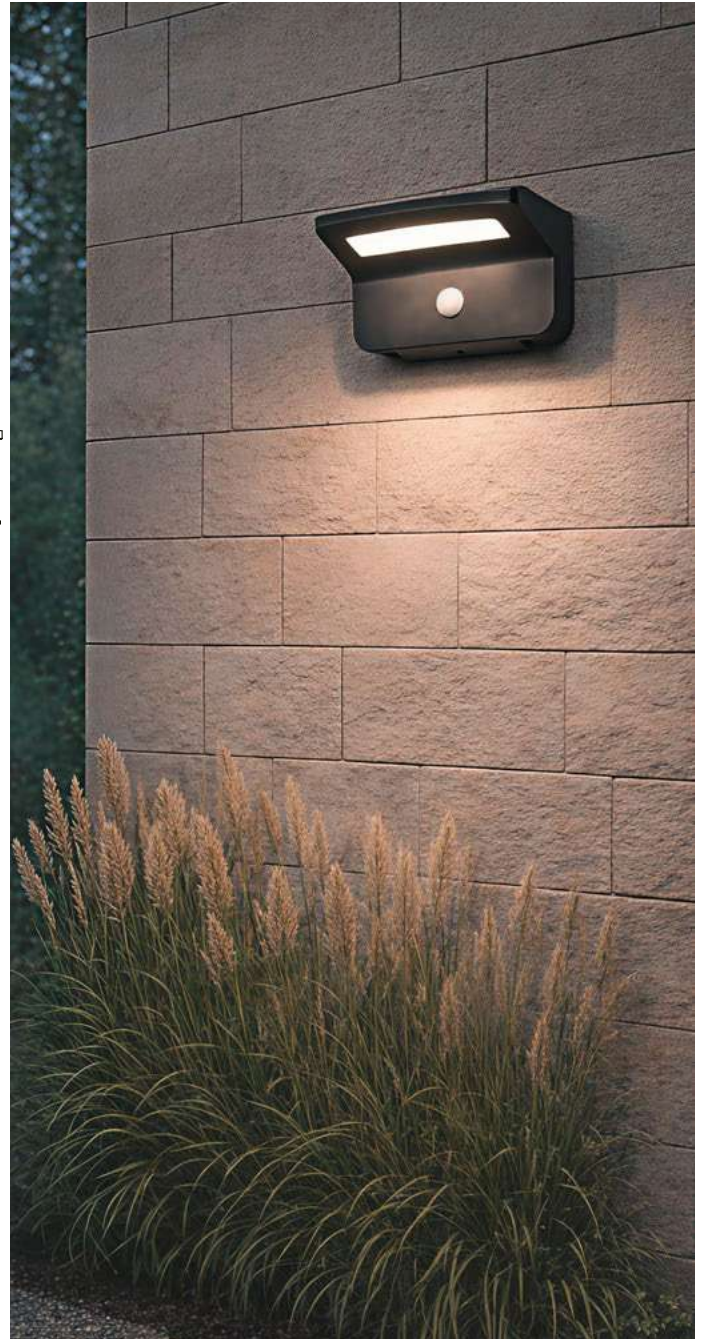
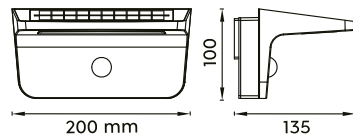

3 Helligkeitsstufen: 100%, 50%, 25%
3 brightness level: 100%, 50%, 25%

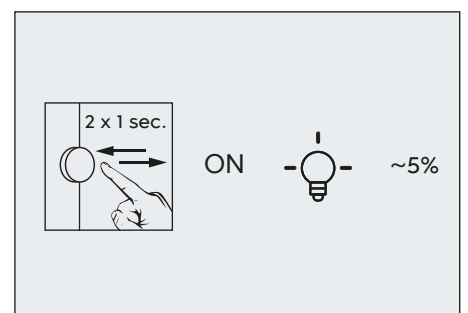
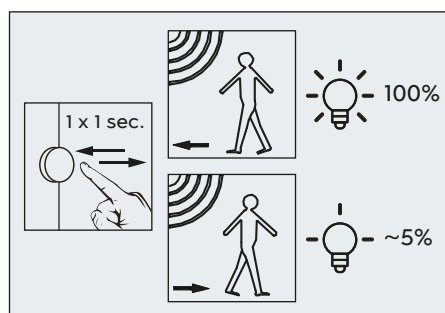
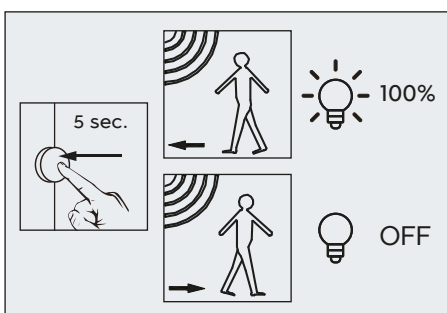

Mit der Kraft der Sonne nachhaltig beleuchten

Sustainable lighting with the power of the sun

Solarleuchten nutzen ausschließlich die Kraft der Sonne um Licht zu erzeugen. Dabei sind sie extrem umwelt-schonend, sparsam und gleichermaßen praktisch, da sie weder Steckdosen noch einen Anschluss ans Stromnetz benötigen. In Kombination mit moderner LED-Technik bieten Solarleuchten ideales Licht für Haus und Garten.

Solar lamps exclusively use the power of the sun to generate light. At the same time they are extremely environmentally friendly and economical as well as practical, as they need neither sockets nor a connection to the mains supply. In combination with modern LED technology, solar lamps provide an ideal light for home and garden.

Les lampes solaires utilisent exclusivement l'énergie du soleil pour générer de la lumière. En même temps, elles sont extrêmement écologiques, économiques et tout aussi pratiques, car elles ne nécessitent ni prise de courant ni raccordement au réseau électrique. En combinaison avec la technologie LED moderne, les lampes solaires fournissent une lumière idéale pour la maison et le jardin.

Zonnelampen maken uitsluitend gebruik van de kracht van de zon om licht te produceren. Daarbij zijn ze extreem milieuvriendelijk, zuinig en in gelijke mate praktisch, omdat ze noch een stopcontact noch een aansluiting op het stroomnet nodig hebben. In combinatie met moderne ledtechniek bieden zonnelampen ideaal licht voor huis en tuin.





LED-Solarleuchten

LED solar lights

Las luces solares usan exclusivamente la energía del sol para generar luz. Al mismo tiempo, son extremadamente ecológicas, económicas e igualmente prácticas, y no necesitan ni enchufes ni conexión a la corriente. En combinación con las modernas técnicas LED, las luces solares ofrecen una luz ideal para la casa y el jardín.

Le lampade solari utilizzano esclusivamente la potenza del sole per generare luce. Allo stesso tempo sono estremamente rispettose dell'ambiente, economiche e pratiche in quanto non richiedono né presa di corrente, né un collegamento alla rete elettrica. In combinazione con la moderna tecnologia LED, le lampade solari forniscono una luce ideale per la casa e il giardino.

Lămpile solare se folosesc în exclusivitate de energia soarelui pentru a genera lumină. În acest context sunt extrem de ecologice, economice și practice în același timp, deoarece nu necesită nici prize și nici conectarea la o rețea electrică. În combinație cu tehnologia modernă LED, lămpile solare oferă lumina ideală pentru casă și grădină.

Aurinkovalaisimet käyttävät auringon energiaa valon tuottamiseen. Samalla ne ovat erittäin ympäristöystävällisiä, taloudellisia ja myös käytännöllisiä, koska ne eivät vaadi pistorasioita tai liitäntää sähköverkkoon. Yhdessä modernin LED-tekniikan kanssa aurinkovalaisimet tarjoavat ihanteellisen valaistuksen kotiin ja puutarhaan.

Lampy solarne wykorzystują moc słońca do generowania światła. Są one przy tym niezwykle przyjazne dla środowiska, ekonomiczne i jednocześnie praktyczne, ponieważ nie wymagają gniazd ani podłączenia do sieci elektrycznej. W połączeniu z nowoczesną technologią LED lampy solarne zapewniają idealne oświetlenie domu i ogrodu.

VIAMAO

Kunststoff · Plastic ·
Plastique · Kunststoff · Plástico ·
Plastica · Plastic · Muovi · Plastik

○ 01 | Weiß · white



Bewegungssensor und Orientierungslicht ·
Motion sensor and orientation light

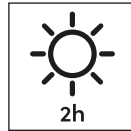
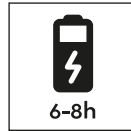
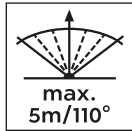

Wandleuchte · Wall lamp
incl. SMD-LED
4 W / 400 Lumen
4.000 Kelvin
R23166101

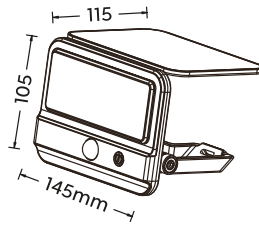

OLINDA

Kunststoff · Plastic ·
Plastique · Kunststoff · Plástico ·
Plastica · Plastic · Muovi · Plastik

● 02 | Schwarz · black



Bewegungssensor und Orientierungslicht ·
Motion sensor and orientation light

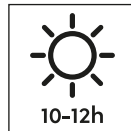
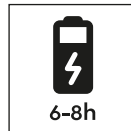
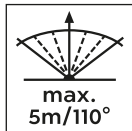

Wandleuchte · Wall lamp
incl. SMD-LED
2,5 W / 250 Lumen
4.000 Kelvin
R23156102

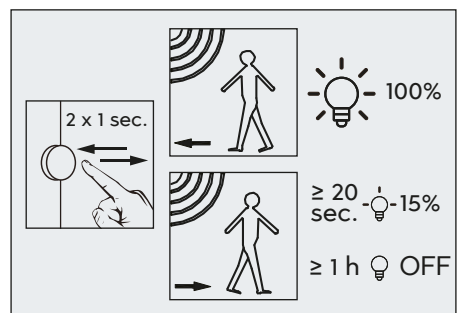
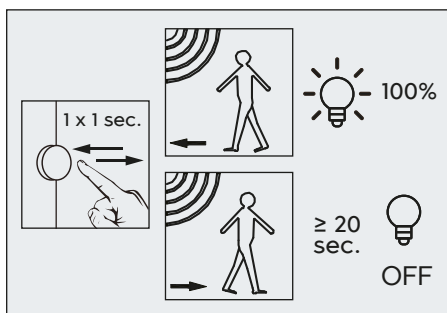
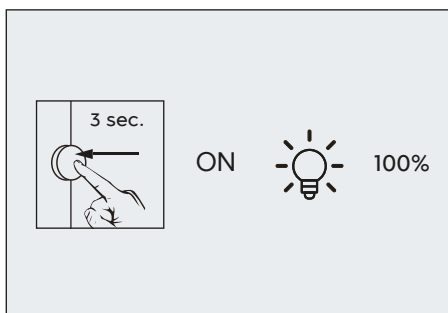
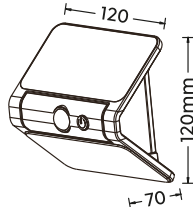

LAGOAS

Kunststoff · Plastic ·
Plastique · Kunststoff · Plástico ·
Plastica · Plastic · Muovi · Plastik



Bewegungssensor und Orientierungslicht ·
Motion sensor and orientation light

02 | Schwarz · black

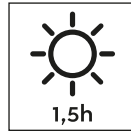
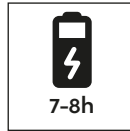
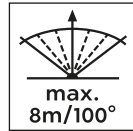

Wandleuchte · Wall lamp

incl. SMD-LED
3 W / 350 Lumen
4.000 Kelvin

R23176102

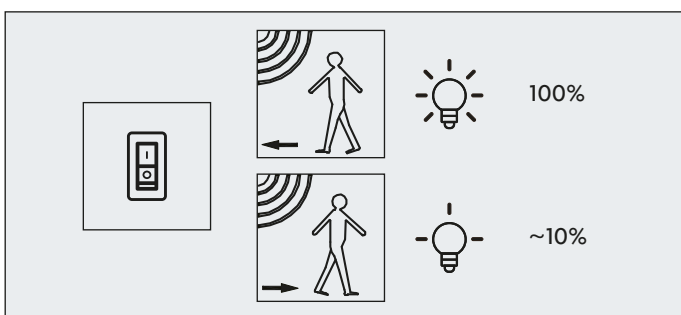
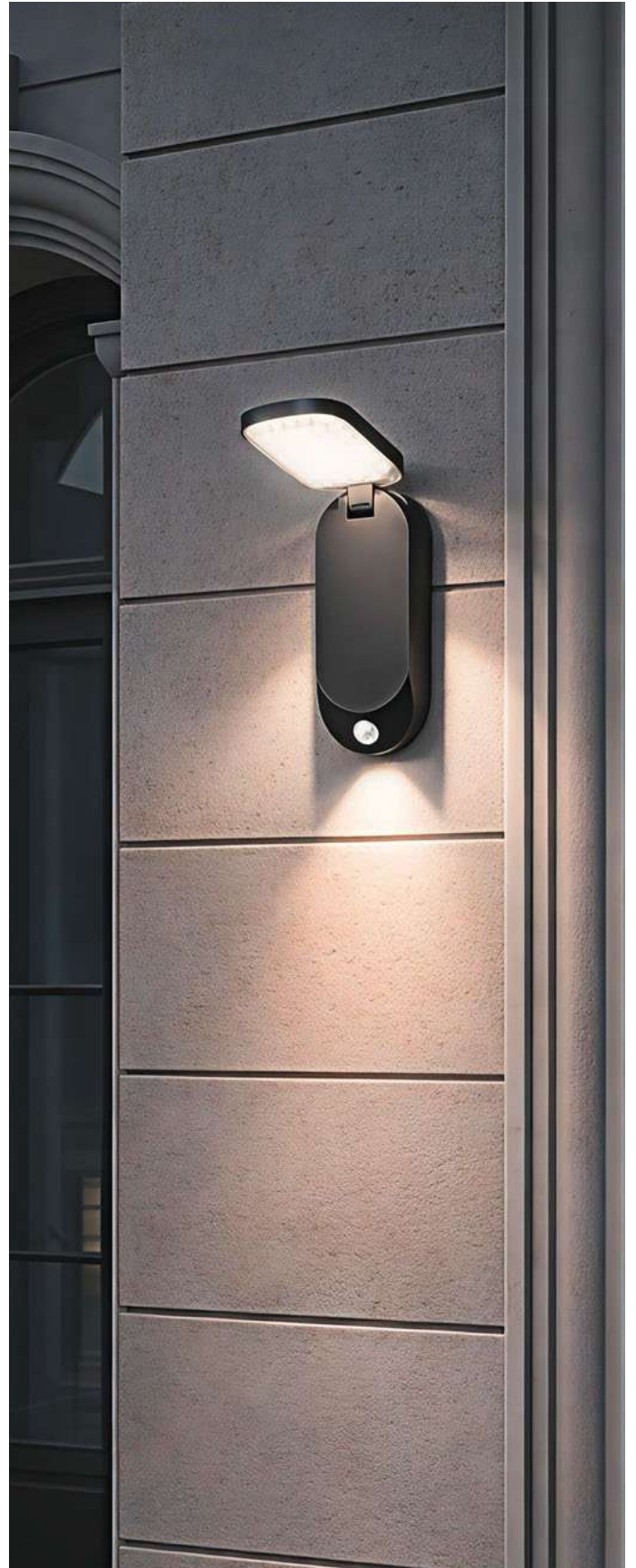
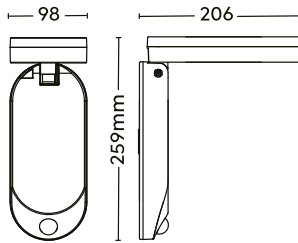

POSADAS

Kunststoff · Plastic ·
Plastique · Kunststof · Plástico ·
Plastica · Plastic · Muovi · Plastik

42 | Anthrazit · anthracite



Wandleuchte · Wall lamp
incl. SMD-LED
4,5 W / 290 Lumen
3.000 Kelvin
R22251142

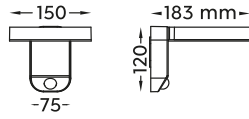

Bewegungssensor ·
Motion sensor

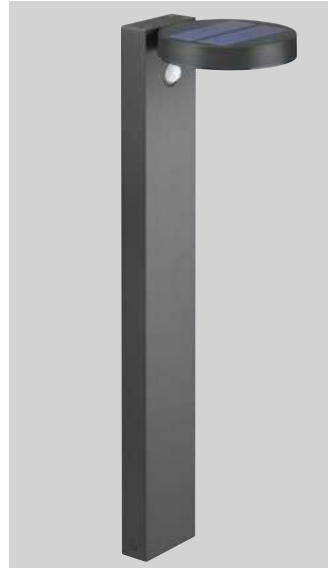
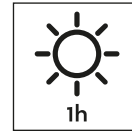
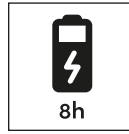
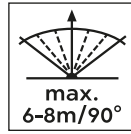

Bodenleuchte · Floor lamp
incl. SMD-LED
4,5 W / 290 Lumen
3.000 Kelvin
R42251142

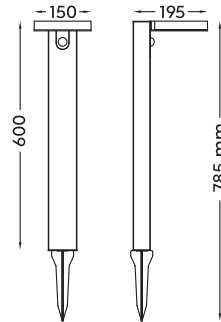

ESQUEL

Kunststoff · Plastic ·
Plastique · Kunststof · Plástico ·
Plastica · Plastic · Muovi · Plastik

42 | Anthrazit · anthracite



Wandleuchte · Wall lamp
incl. SMD-LED
4,5 W / 290 Lumen
3.000 Kelvin
R22261142

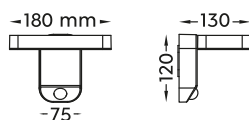

Bewegungssensor ·
Motion sensor

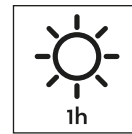
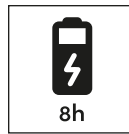
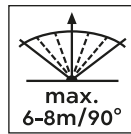

Bodenleuchte · Floor lamp
incl. SMD-LED
4,5 W / 290 Lumen
3.000 Kelvin
R42261142

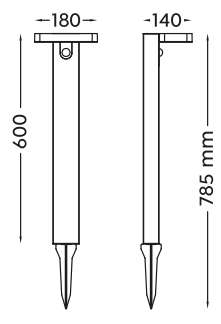





MOURA

Aluminium Druckguss, Kunststoff · Diecast aluminium, plastic ·
 Fonte d'aluminium, plastique · Gegoten aluminium, kunststof ·
 Aluminio fundido, plástico · Pressofusione di alluminio, plastica ·
 Fonta aluminiu, plastic · Valualumiini, muov · Barwione aluminium, plastik

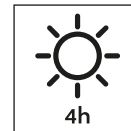
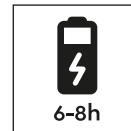
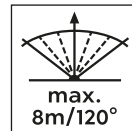

 Bewegungssensor ·
 Motion sensor



 32 | Schwarz matt · black mat



Wandleuchte · Wall lamp
 incl. SMD-LED
 10 W / 1.100 Lumen
 3.000 + 4.000 + 6.000 Kelvin
R22109132



 IP54

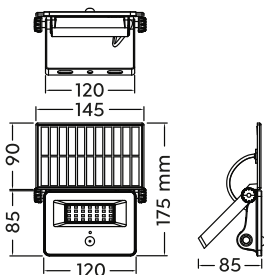

Wandleuchte · Wall lamp
 incl. SMD-LED
 18 W / 2.150 Lumen
 3.000 + 4.000 + 6.000 Kelvin
R22106132



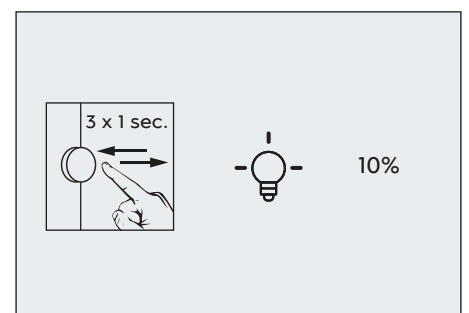
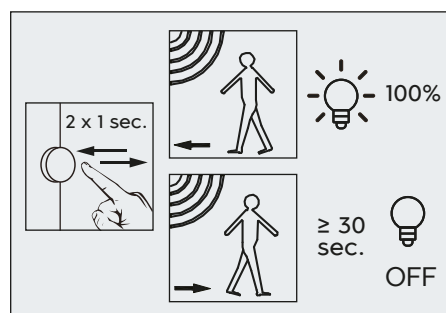
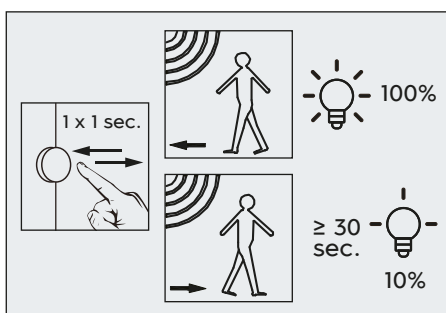
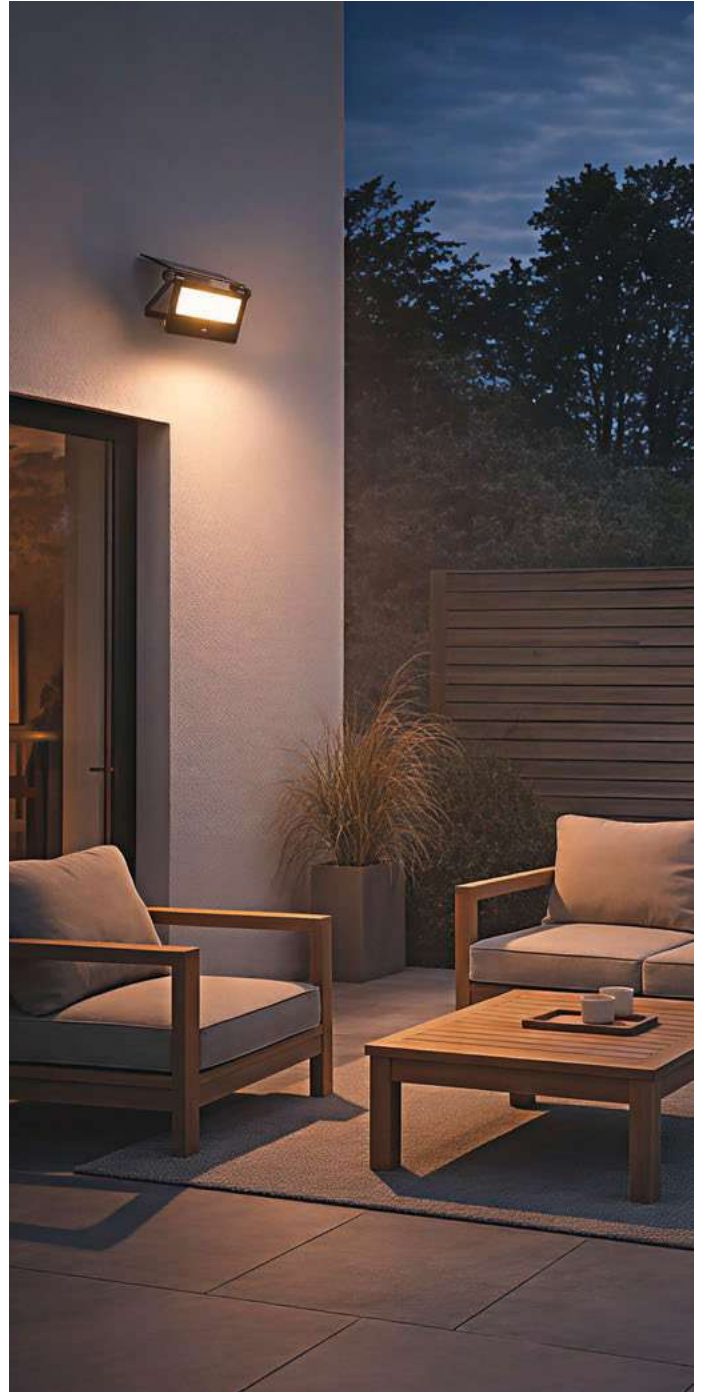
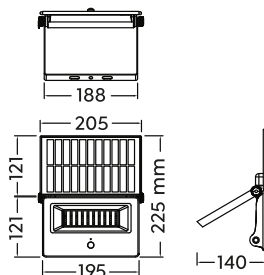

 IP54



SALTA

Metall, Acryl · Metal, acryl ·
 Metale, acryl · Metaal, acryl · Metal, acrílico ·
 Metallo, acrílico · Metal, acrylic · Metall, akryyli · Metal, akryl

-  **07** | Nickel matt · nickel mat
-  **42** | Anthrazit · anthracite



 Bewegungssensor ·
 Motion sensor

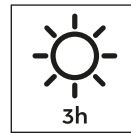
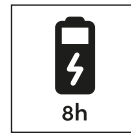
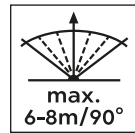

Wandleuchte · Wall lamp
 incl. SMD-LED
 3 W / 165 Lumen
 3.000 Kelvin
R22231107
R22231142

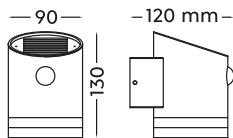

FOMOSA

Kunststoff · Plastic ·
 Plastique · Kunststof · Plástico ·
 Plastica · Plastic · Muovi · Plastik

-  **42** | Anthrazit · anthracite



 Bewegungssensor ·
 Motion sensor

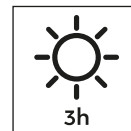
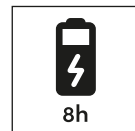
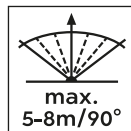

Wandleuchte · Wall lamp
 incl. SMD-LED
 4,8 W / 340 Lumen
 3.000 Kelvin
R22281142

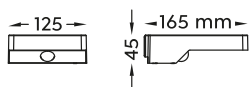

MACAPA

Kunststoff · Plastic ·
Plastique · Kunststoff · Plástico ·
Plastica · Plastic · Muovi · Plastik

01 | Weiß · white



Bewegungssensor und Orientierungslicht ·
Motion sensor and orientation light

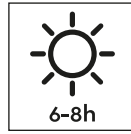
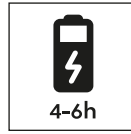
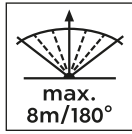

Wandleuchte · Wall lamp
incl. SMD-LED
5 W / 390 Lumen
4.000 Kelvin
R23066101

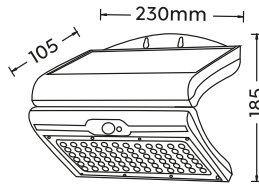

DIADEMA

Kunststoff · Plastic ·
Plastique · Kunststoff · Plástico ·
Plastica · Plastic · Muovi · Plastik

01 | Weiß · white



Bewegungssensor und Orientierungslicht ·
Motion sensor and orientation light

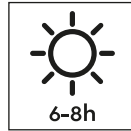
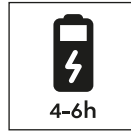
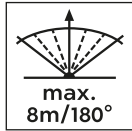

Wandleuchte · Wall lamp
incl. SMD-LED
3,5 W / 300 Lumen
4.000 Kelvin
R23146101

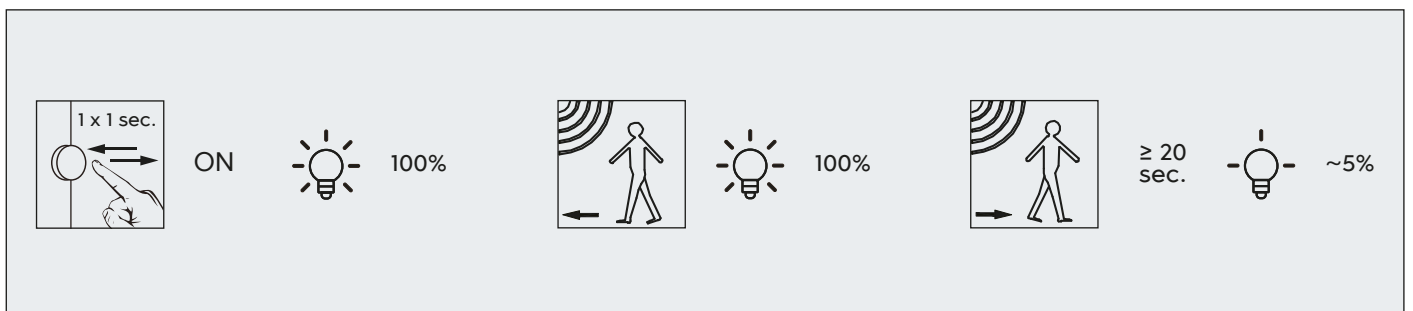
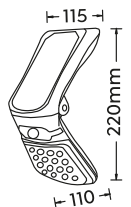

ACORA

Kunststoff · Plastic ·
Plastique · Kunststoff · Plástico ·
Plastica · Plastic · Muovi · Plastik



 Bewegungssensor ·
Motion sensor

 **32** | Schwarz matt · black mat

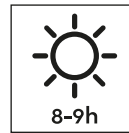
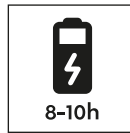
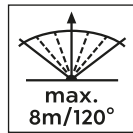

Wandleuchte · Wall lamp

incl. SMD-LED
18 W / 2600 Lumen
4.000 Kelvin
R22189132

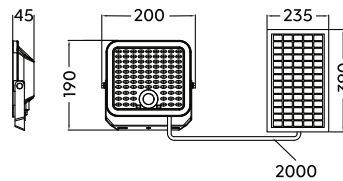

Helligkeit und Leuchtdauer über
Timer einstellbar ·
Brightness and light duration
adjustable via timer

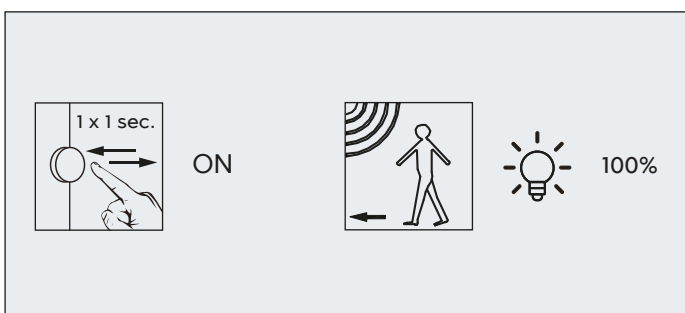

ELVAS

Kunststoff · Plastic ·
Plastique · Kunststoff · Plástico ·
Plastica · Plastic · Muovi · Plastik

○ 31 | Weiß matt · white mat

● 32 | Schwarz matt · black mat



Bewegungssensor ·
Motion sensor



Dämmerungssensor ·
Dusk sensor

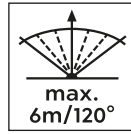

31



32

Wandleuchte · Wall lamp

incl. SMD-LED
3 W / 380 Lumen
4.000 Kelvin

R251296**31**
R251296**32**

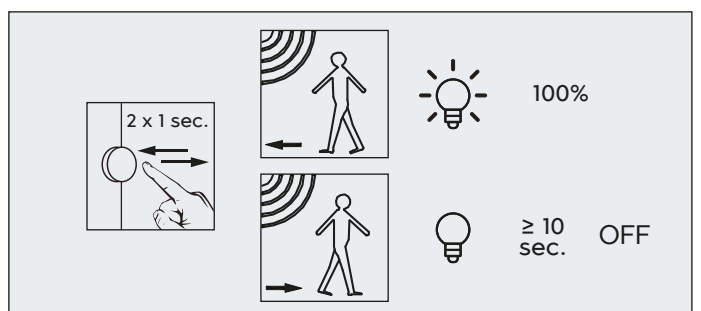
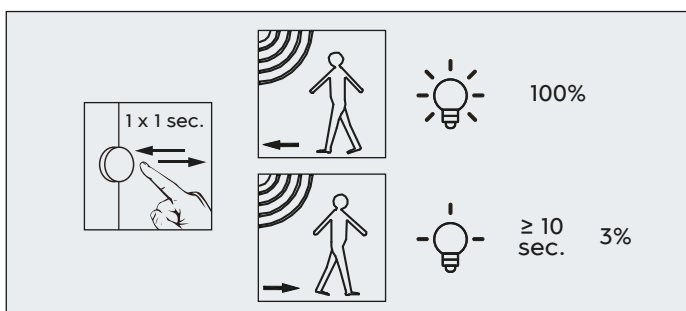
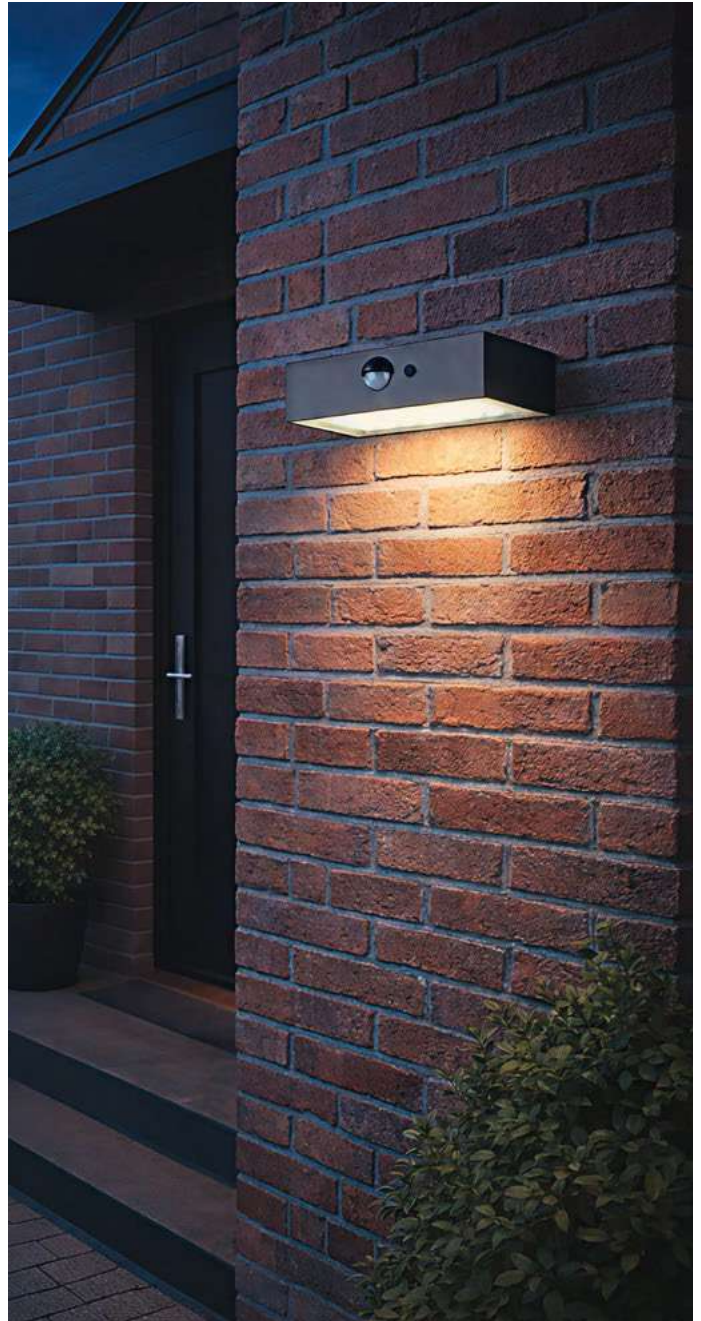
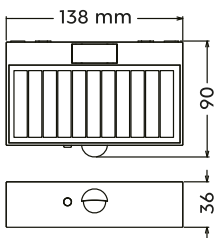

TALCA

Kunststoff · Plastic ·
Plastique · Kunststoff · Plástico ·
Plastica · Plastic · Muovi · Plastik

○ 31 | Weiß matt · white mat

● 32 | Schwarz matt · black mat



 Bewegungssensor ·
Motion sensor

 Dämmerungssensor ·
Dusk sensor

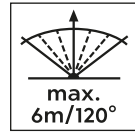

Wandleuchte · Wall lamp
incl. SMD-LED
2,5 W / 330 Lumen
3.000 + 4.000 + 6.000 Kelvin
R25119631
R25119632

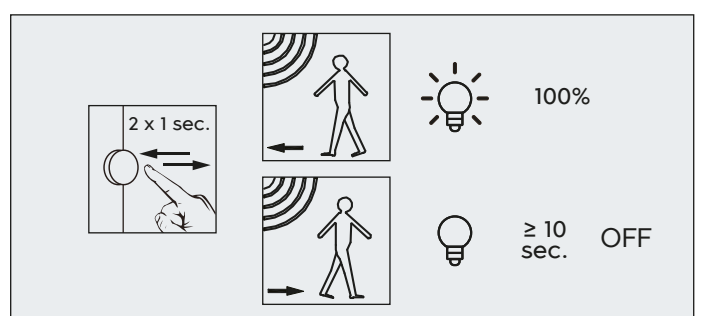
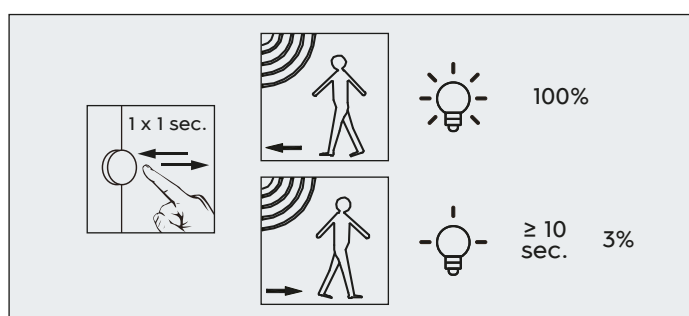
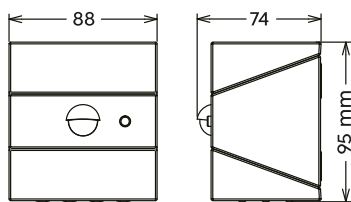

MELO

Kunststoff · Plastic ·
Plastique · Kunststof · Plástico ·
Plastica · Plastic · Muovi · Plastik

 RGBW Farbwechsler ·
RGBW Colorchanging



 **01** | Weiß · white



Gartenleuchte · Garden lamp
incl. RGBW-LED
0,5 W / 30 Lumen
3.000 Kelvin
R55326101

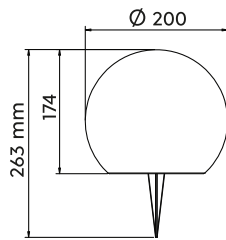

Gartenleuchte · Garden lamp
incl. RGBW-LED
0,5 W / 30 Lumen
3.000 Kelvin
R55326901

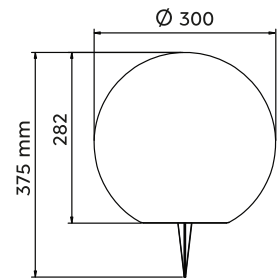



OBIDOS

Kunststoff · Plastic ·
Plastique · Kunststoff · Plástico ·
Plastica · Plastic · Muovi · Plastik

● 32 | Schwarz matt · black mat



Dämmerungssensor ·
Dusk sensor



7h



5,5h

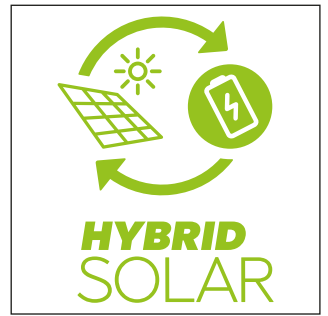

Strahler · Spot

incl. 3 x SMD-LED
3 x 0,5 W / 3 x 35 Lumen
4.000 Kelvin

R83256332

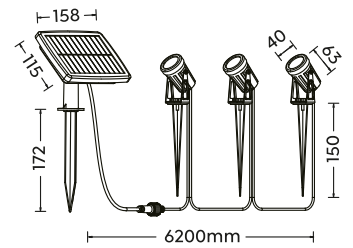



FESTIVAL

Kunststoff · Plastic ·
Plastique · Kunststoff · Plástico ·
Plastica · Plastic · Muovi · Plastik

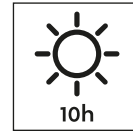
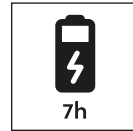
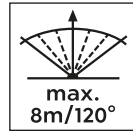

 Dämmerungssensor ·
Dusk sensor



 32 | Schwarz matt · black mat



Strahler · Spot
incl. SMD-LED
1 W / 35 Lumen
3.000 Kelvin
R84756232

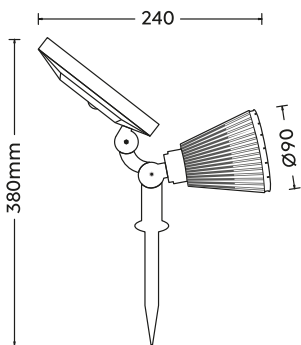

MOOD

Kunststoff · Plastic ·
Plastique · Kunststoff · Plástico ·
Plastica · Plastic · Muovi · Plastik

● 32 | Schwarz matt · black mat

☾☀️ Dämmerungssensor ·
Dusk sensor

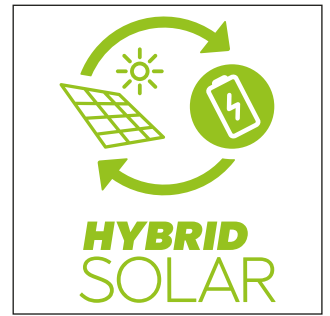
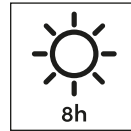
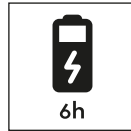

Lichterkette · Fairy lights
incl. 10 x LED-E12
10 x 0,5 W / 10 x 30 Lumen
2.700 Kelvin
R74761132

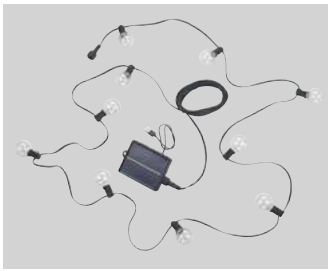
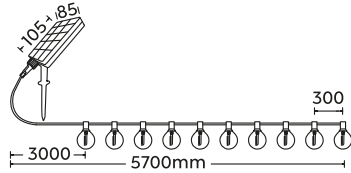

CAMPUS

Metall, Kunststoff · Metal, plastic ·
Metale, plastique · Metaal, kunststof · Metal, plástico ·
Metallo, plastica · Metal, plastic · Metalli, muovi · Metal, plastik

● 32 | Schwarz matt · black mat

☾☀️ Dämmerungssensor ·
Dusk sensor

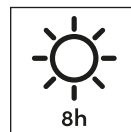
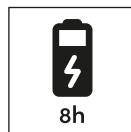

3er Set / Set 3

Gartenleuchte · Garden lamp
incl. 3 x SMD-LED
3 x 0,1 W
R35146132

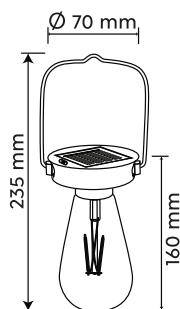

MOOD

Kunststoff · Plastic ·
 Plastique · Kunststoff · Plástico ·
 Plastica · Plastic · Muovi · Plastik

● 32 | Schwarz matt · black mat

☾☀️ Dämmerungssensor ·
 Dusk sensor

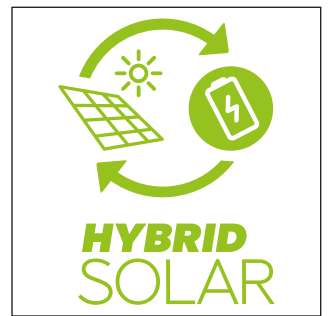
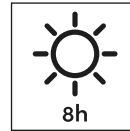
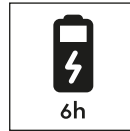

Lichterkette · Fairy lights
 incl. 10 x LED-E12
 10 x 0,5 W / 10 x 30 Lumen
 2.700 Kelvin
R74761932

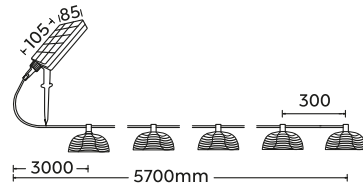

Gracias a la batería integrada, las luces transportables son flexibles y aportan puntos de atención excitantes al jardín, al balcón o a la terraza - ¡y sin ningún tipo de cables! Se consigue el ambiente adecuado con otras características especiales adicionales como el modificador de color RGB o la función Bluetooth para escuchar música sin cables. La iluminación perfecta para pasar la tarde con la familia y los amigos.

Dank integriertem Akku sind die transportablen Leuchten flexibel und setzen spannende Akzente im Garten, auf dem Balkon oder der Terrasse - ganz ohne Kabel! Für die richtige Stimmung sorgen zusätzliche Highlights wie RGB-Farbwechsler oder Bluetooth-Funktion für kabelloses Musik hören. Die perfekte Beleuchtung für gemeinsame Abendstunden mit Familie und Freunden.

Grazie alla batteria ricaricabile integrata, le lampade portatili sono flessibili e creano accenti emozionanti in giardino, sul balcone o sulla terrazza - senza cavi! Ulteriori punti di forza come il cambiacolori RGB o la funzione Bluetooth per l'ascolto di musica senza fili assicurano il giusto feeling. L'illuminazione perfetta per le ore serali da trascorrere insieme alla famiglia e agli amici.

Integrated rechargeable batteries lets you flexibly use these easily transportable lights to accent your garden, balcony or terrace in an exciting way, all without any cables! Additional highlights like an RGB colour wheels and Bluetooth for streaming music wirelessly provide just the right mood. The perfect lighting for spending evening hours with family and friends.

Datorită acumulatorului integrat, lămpile transportabile sunt flexibile și oferă un aspect atrăgător în grădină, pe balcon sau pe terasă - fără cablu! Atmosfera potrivită este asigurată de jocurile suplimentare de lumină cum ar fi schimbarea culorilor RGB sau funcția Bluetooth pentru a asculta muzică fără cablu. Iluminarea perfectă pentru orele de seară cu familia și prietenii.

Grâce à la batterie rechargeable intégrée, les lampes transportables sont flexibles et mettent des accents excitants dans le jardin, sur le balcon ou la terrasse - sans aucun câble ! D'autres fonctions marquantes garantissent une bonne ambiance, telles que le changeur de couleurs RVB ou la fonction Bluetooth pour l'écoute de musique sans fil. L'éclairage parfait pour les soirées partagées avec la famille et les amis.

Integroidun ladattavan akun ansiosta siirrettävät valaisimet ovat joustavia ja muodostavat jännittäviä korostuksia puutarhaan, parvekkeelle tai terassille - ilman kaapeleita! Lisäkorostukset, kuten RGB-väri vaihtajat tai Bluetooth-toiminto langattomaan musiikin kuuntelun, takaavat oikean ilmapiirin. Täydellinen valaistus illanviettoon yhdessä perheen ja ystävien kanssa.





Dankzij de geïntegreerde accu zijn de verplaatsbare lampen flexibel en zorgen voor mooie accenten in de tuin, op het balkon of op het terras, en dat helemaal zonder kabel! Voor de juiste stemming zorgen extra hoogtepunten zoals de RGB-kleurenwisselaar of Bluetooth-functie om draadloos muziek te beluisteren. De perfecte verlichting om 's avonds aangenaam te vertoeven met vrienden en familie.



Dzięki akumulatorowi przenośne lampy są elastyczne w ustawieniu i tworzą ekscytujące akcenty w ogrodzie, na balkonie lub tarasie - bez żadnych kabli! Odpowiedni nastrój zapewnią dodatkowe urządzenia, takie jak zmieniające kolorów RGB lub funkcja Bluetooth do bezprzewodowego słuchania muzyki. Doskonałe oświetlenie wspólnych wieczorów z rodziną i przyjaciółmi.



SUAREZ

Metall · Metal ·
Metale · Metaal · Metal ·
Metallo · Metal · Metalli · Metal

-  **31** | Weiß matt · white mat
-  **32** | Schwarz matt · black mat
-  **49** | Pistaziengrün · pistachio green
-  **66** | Sand · sable

-  On/Off Touch Funktion ·
On/Off Touch function
-  Sensordimmer ·
Sensor dimmer
-  USB-C Anschluss ·
USB-C connection

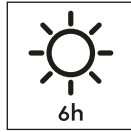
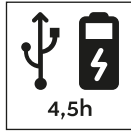

OUTDOOR
living



Tischleuchte · Table lamp
incl. SMD-LED
1,5 W / 200 Lumen
3.000 Kelvin
R57706131
R57706132
R57706149
R57706166



 Inklusive Ladestation ·
Charging station included



Stehleuchte · Floor lamp
incl. SMD-LED
1,5 W / 200 Lumen
3.000 Kelvin
R57706131
R57706132
R57706149
R57706166

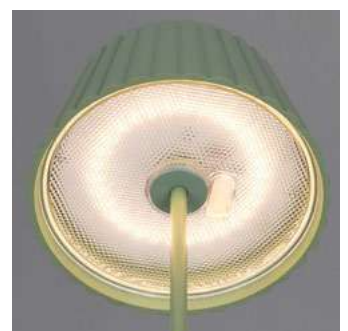
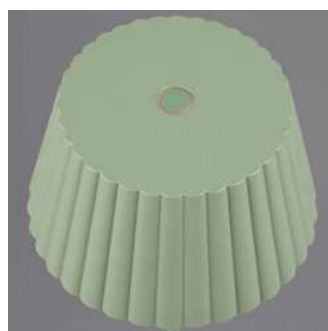
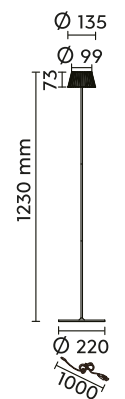



FERNANDEZ

Metall, Kunststoff · Metal, plastic ·
 Metale, plastique · Metaal, kunststof · Metal, plástico ·
 Metallo, plastica · Metal, plastic · Metalli, muovi · Metal, plastik

○ 31 | Weiß matt · white mat

● 32 | Schwarz matt · black mat

☾ Lichtfarbe einstellbar ·
 Adjustable light color

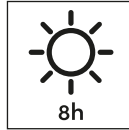
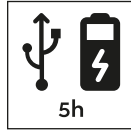

OUTDOOR
 living



31



32

Tischleuchte · Table lamp
 incl. SMD-LED
 1,5 W / 130 Lumen
 2.700 + 4.000 + 6.000 Kelvin
R54096131
R54096132

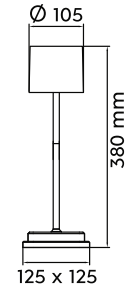
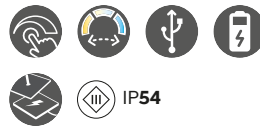

31



32

6er Set / Set 6
 Inklusive Ladestation
 Charging station included
R54096631
R54096632

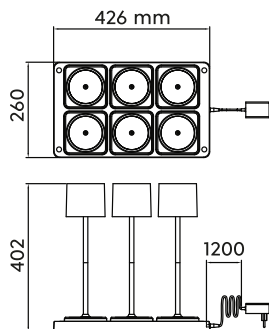

Ladestation · Charging station
R54099602

☼ IP20

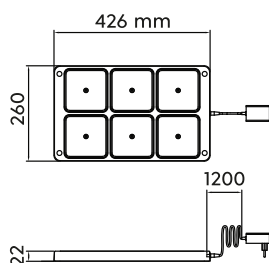

LENNON

Kunststoff · Plastic ·
Plastique · Kunststof · Plástico ·
Plastica · Plastic · Muovi · Plastik

- 01 | Weiß · white
- 02 | Schwarz · black
- 49 | Pistaziengrün · pistachio green
- 83 | Illuminate Gelb · illuminate yellow

- 4 fach TOUCH ·
4 level Touch function
- USB-C Anschluss ·
USB-C connection

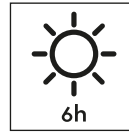
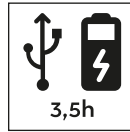

OUTDOOR
living



Tischleuchte · Table lamp

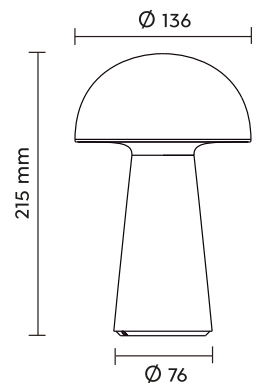

incl. SMD-LED
2 W / 180 Lumen
3.000 Kelvin
R52176101
R52176102
R52176149
R52176183



DIAZ

Metall · Metal ·
 Metale · Metaal · Metal ·
 Metallo · Metal · Metalli · Metal

- 31** | Weiß matt · white mat
- 32** | Schwarz matt · black mat
- 49** | Pistaziengrün · pistachio green
- 66** | Sand · sable
- 77** | Ultimate Grau · ultimate grey

-  Lichtfarbe stufenlos einstellbar ·
Light color infinitely variable
-  4 fach TOUCH ·
4 level Touch function
-  Akkubetrieb ·
Rechargeable battery operated

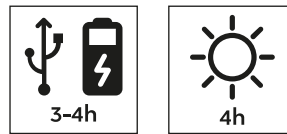

OUTDOOR
living



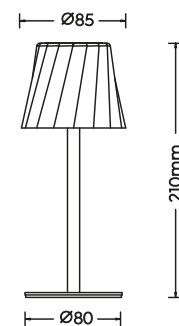

Wandleuchte · Wall lamp
 incl. SMD-LED
 1,6 W / 160 Lumen
 2.700 - 6.500 Kelvin
R55961131
R55961132
R55961149
R55961166
R55961177



RICARDO

Kunststoff · Plastic ·
Plastique · Kunststoff · Plástico
Plastica · Plastic · Muovi · Plastik

- 10** | Rot · red
- 31** | Weiß matt · white mat
- 32** | Schwarz matt · black mat
- 49** | Pistaziengrün · pistachio green
- 65** | Coffee · coffee

-  4 fach TOUCH ·
4 level Touch function
-  USB-C Anschluss ·
USB-C connection
-  Akkubetrieb ·
Rechargeable battery operated

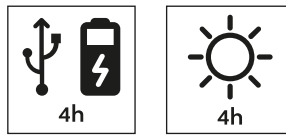

OUTDOOR
living



Wandleuchte · Wall lamp

incl. SMD-LED
1,7 W / 240 Lumen
3.000 Kelvin

R54106110
R54106131
R54106132
R54106149
R54106165

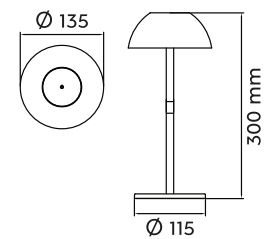

PALMAS

Kunststoff · Plastic ·
Plastique · Kunststoff · Plástico ·
Plastica · Plastic · Muovi · Plastik

01 | Weiß · white

RGBW Farbwechsler ·
RGBW Colorchanging

Memory Funktion ·
Memory function

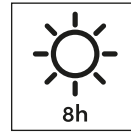
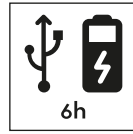

OUTDOOR
living



Gartenleuchte · Garden lamp
incl. SMD-LED
3 W / 90 Lumen
3.000 Kelvin
R45101101

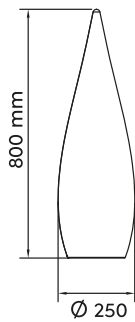

Gartenleuchte · Garden lamp
incl. SMD-LED
4,5 W / 120 Lumen
3.000 Kelvin
R45101901

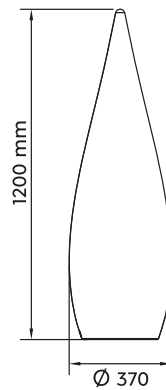



ARUBA

Kunststoff · Plastic ·
Plastique · Kunststof · Plástico ·
Plastica · Plastic · Muovi · Plastik

01 | Weiß · white

RGBW Farbwechsler ·
RGBW Colorchanging

USB Anschluss ·
USB connection

OUTDOOR
living

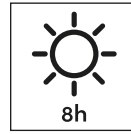
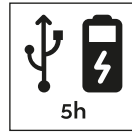

Tischleuchte · Table lamp
incl. SMD-LED
1 W / 70 Lumen
3.000 Kelvin
R57080101

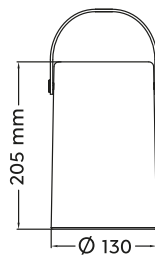

JAMAICA

Kunststoff · Plastic ·
Plastique · Kunststoff · Plástico ·
Plastica · Plastic · Muovi · Plastik

01 | Weiß · white

OUTDOOR
living

- RGBW Farbwechsler · RGBW Colorchanging
- Bluetooth Lautsprecher · Bluetooth loudspeaker

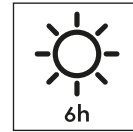
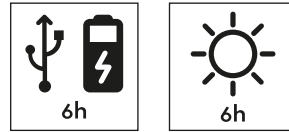

Tischleuchte · Table lamp
incl. SMD-LED
2,5 W / 25 Lumen
3.000 Kelvin
R55086101



IP44

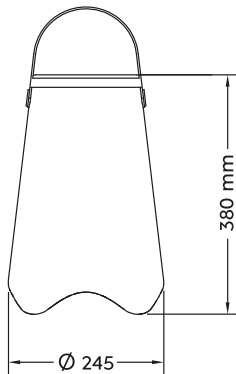

EMBER

Kunststoff, Hanf naturbelassen · Plastic, hemp natural finish ·
Plastique, chanvre finition naturelle · Kunststof, Hennep natuurlijke afwerking ·
Plástico, cáñamo con acabado natural · Plastica, canapa finitura naturale ·
Plastic, cânepă cu finisaj natural · Muovi, Luonnollinen hamppu · PlastikPlastik, Konopie naturalne

OUTDOOR
living

02 | Schwarz · black



Lichterkette · Fairy lights
incl. 8 x SMD-LED
8 x 0,4 W / 8 x 45 Lumen
2.700 Kelvin
R74938602

IP44

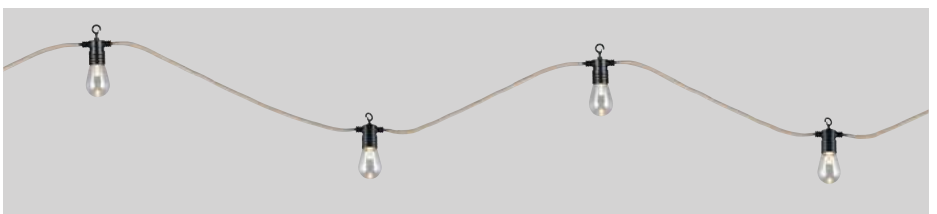
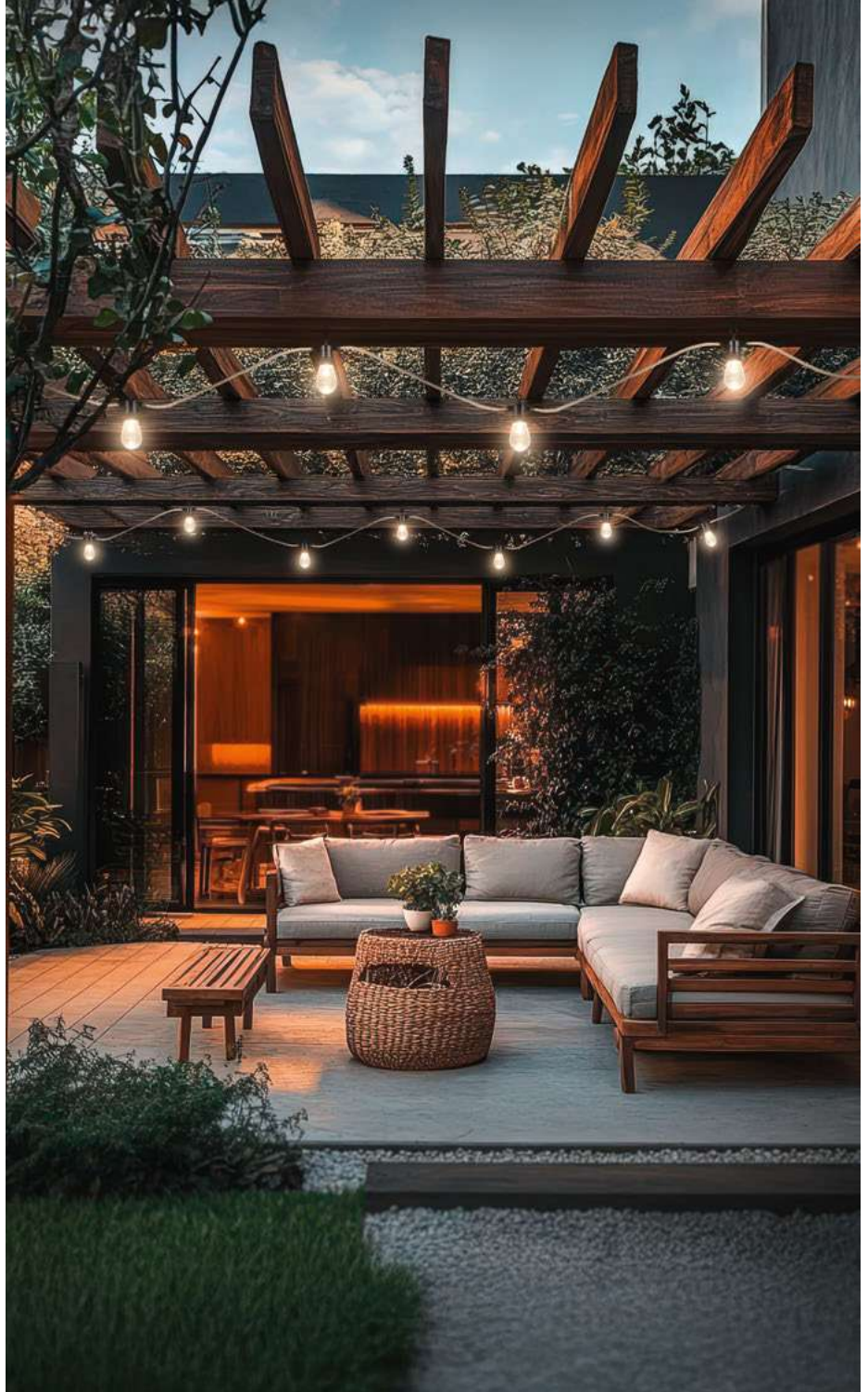
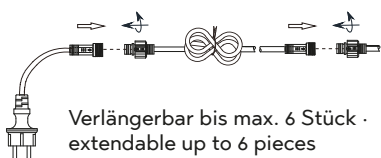
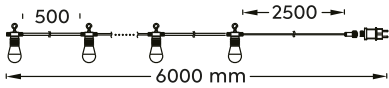

CHAIN

Kunststoff, Papiergarn naturbelassen · Plastic, paper yarn natural finish ·

Plastique, fil de papier finition naturelle · Kunststof, Papier garen natuurlijke afwerking ·

Plástico, hilo de papel con acabado natural · Plastica, filato di carta finitura naturale ·

Plastic, fir de hârtie cu finisaj natural · Muovi, paperilanka luonnollinen viimeistely · Plastik, przedza papierowa naturalne wykończenie



32 | Schwarz matt · black mat



Lichterkette · Fairy lights

incl. 10 x LED E27

10 x 1 W / 10 x 80 Lumen

3.000 Kelvin

R74771532

IP44

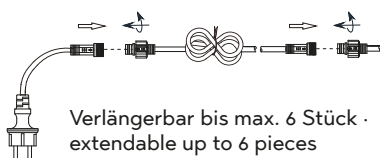
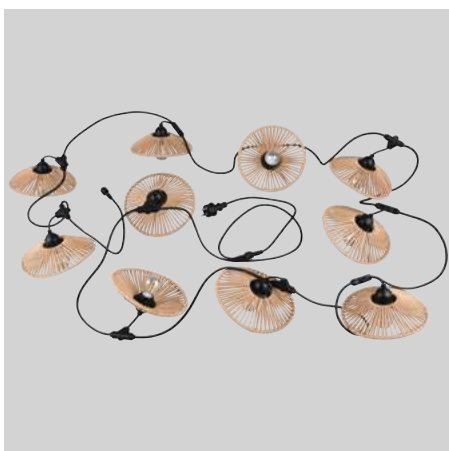
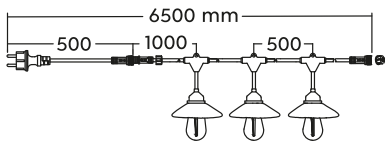

Verlängerbar bis max. 6 Stück ·
extendable up to 6 pieces



CHAIN

Kunststoff · Plastic ·
Plastique · Kunststoff · Plástico ·
Plastica · Plastic · Muovi · Plastik

OUTDOOR
living

● 32 | Schwarz matt · black mat



Lichterkette · Fairy lights
incl. 10 x SMD-LED
10 x 1 W / 10 x 80 Lumen
3.000 Kelvin
R74771132

Ⓜ IP44

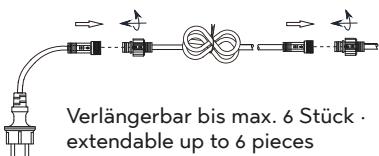
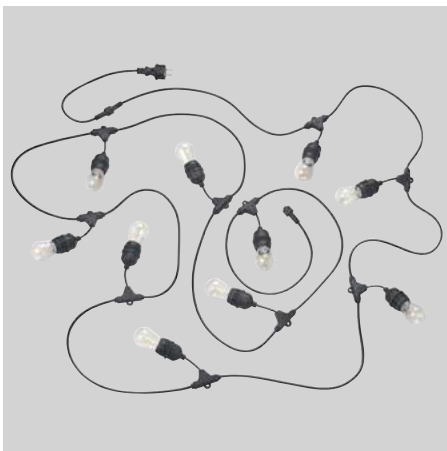
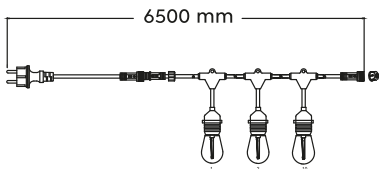

Verlängerbar bis max. 6 Stück ·
extendable up to 6 pieces

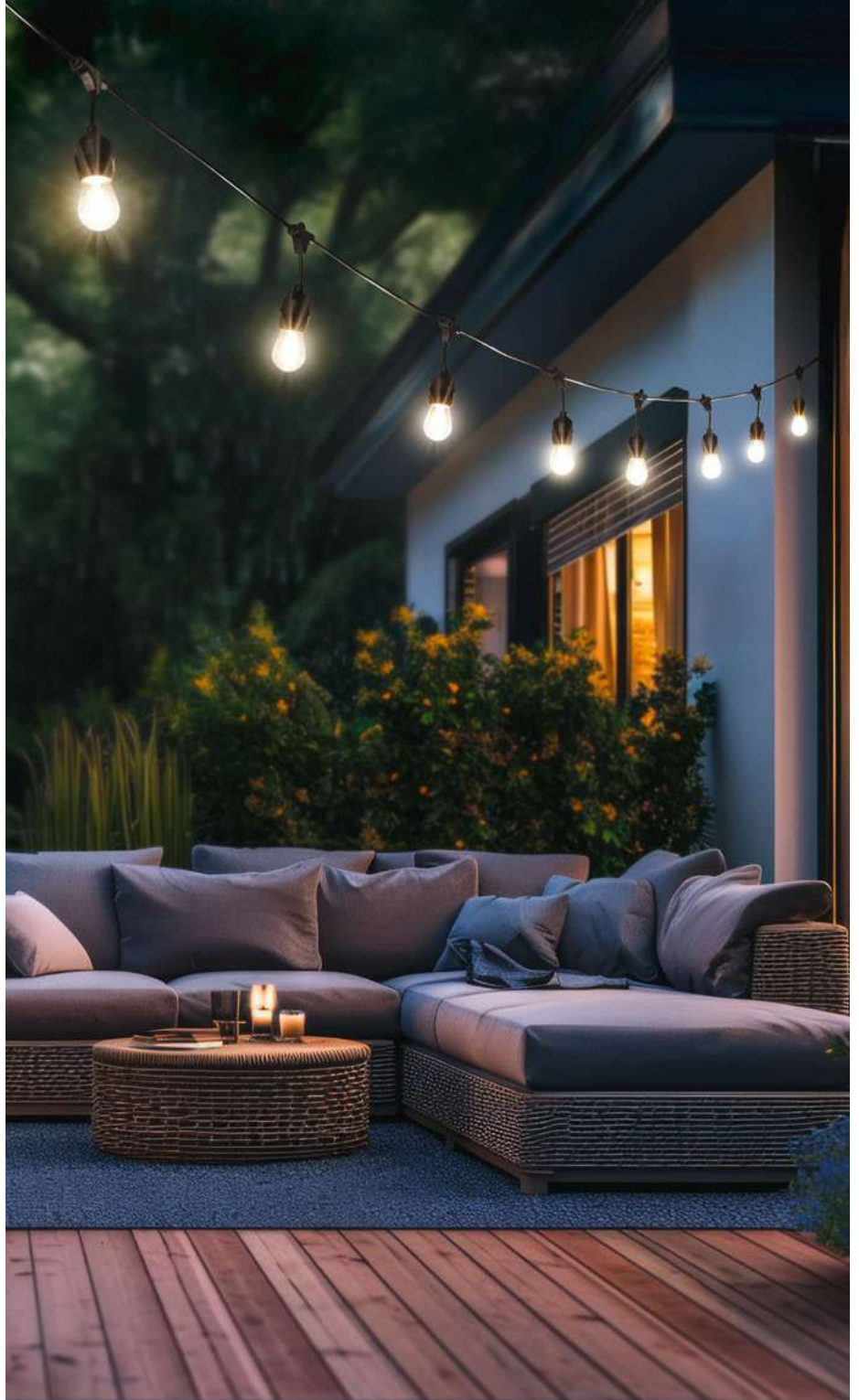

CHAIN

Metall, Kunststoff · Metal, plastic ·
Metale, plastique · Metaal, kunststof · Metal, plástico ·
Metallo, plastica · Metal, plastic · Metalli, muovi · Metal, plastik

OUTDOOR
living

● 32 | Schwarz matt · black mat



Lichterkette · Fairy lights
incl. 10 x SMD-LED
10 x 1 W / 10 x 80 Lumen
3.000 Kelvin
R74771932

IP44

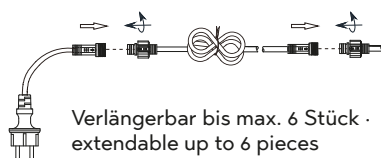
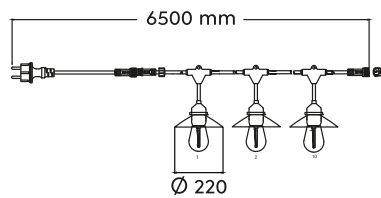

Produkteigenschaften · Features

Caractéristiques · Kenmerken · Acabados · Caratteristiche · Caracteristici · Ominaisuudet · Cechy



Schalter · Switch
Interrupteur · Schakelaar · Interruptor ·
Interruttore · Intrerupator · Kytkin ·
Przełącznik



Fernbedienung · Remote control
Commande à distance · Afstandsbediening ·
Mando a distancia · Comando a distanza ·
Telecomanda · Kauko-ohjain · Pilot



Integrierter Dimmer · Integrated dimmer
Variateur intégré · Geïntegreerde dimmer ·
Regulador integrado · Dimmer integrato ·
Variator de lumina integrat · Integroitu himmennin ·
Wbudowany ściemniacz



Sensordimmer · Sensor dimmer
Variateur tactile · Touchdimmer ·
Regulador con sensor · Touchdimmer ·
Variator cu senzor · Kosketushimmennin ·
Czujnik ściemniania



RGB Farbwechsler · RGB Colorchanging
Changement de couleur RGB · RGB Kleurverandering ·
Cambio de color RGB · Cambia colore RGB ·
Schimbator de culoare RGB · Värvinvaihto RGB ·
Zmieniający kolor RGB



RGBW Farbwechsler · RGBW Colorchanging
Changement de couleur RGBW · RGBW Kleurverandering ·
Cambio de color RGBW · Cambia colore RGBW ·
Schimbator de culoare RGBW · Värvinvaihto RGB ·
Zmieniający kolor RGBW



Lichtfarbe einstellbar · Adjustable light color
Couleur de lumière réglable · Lichtkleur instelbaar ·
Color de luz regulable · Colore della luce regolabile ·
Lumina colorata reglabila · Värilämpötila säädettävissä ·
Regulowana barwa światła



Lichtfarbe stufenlos einstellbar ·
Light color infinitely variable
Couleur de lumière infiniment variable · Lichtkleur
traploos instelbaar · Color de luz infinitamente variable ·
Colore della luce infinitamente variabile · Culoare lumină
infiniți variabilă · Valon väri portaattomasti · Jasny kolor
bezstopniowo



DIP SWITCH
Lichtfarben direkt an der Leuchte einstellbar ·
Colours directly adjustable at the lamp
Les couleurs de la lumière peuvent être réglées
directement sur le luminaire · Lichtkleuren direct
instelbaar op de lamp · Tonalidades de luz ajustables
directamente en la lámpara · Colori della luce regolabili
direttamente sulla lampada · Culori ale luminii reglabile
direct de la bec · Valon väri asetettävissä suoraan
valaisimesta · Barwy światła można ustawić bezpośrednio
na oprawie



Schwenkbar · Slewable
Pivotant · Draaibaar · Pivotante ·
Girevole · Pivotant · Suunnattava ·
Skretny



Up and down Beleuchtung · Up and Down lighting
Point lumineux en haut et en bas · Lichtpunt boven en
onder · Luz de arriba y abajo · Luce su e giù · Sus și în
jos lumina · Ylös ja alas valoa · W górę iw dół światło



Steckdose · Plug
Prise · Stekker · Enchufe · Spina ·
Priza · Katkaisin · Gniazdko



4 fach TOUCH · 4 level Touch function
Interrupteur tactile 4 niveaux · Touch schakelaar 4 niveaus ·
Función Táctil 4 nivel · Interruttore touch 4 livelli ·
Intrerupator tactil 4 nivele · Kosketuskäyttöinen 4 taso ·
Funkcja dotykowa 4 poziomy



Kippbar · Tilttable
Inclinable · Kantelbaar · Basculante ·
Inclinabile · Basculant · Kallistettava ·
Uchylny



On/Off Touch Funktion · On/Off Touch function
Interrupteur tactile On/Off · Touch schakelaar On/Off ·
Función táctil On/Off · Interruttore touch On/Off ·
Intrerupator tactil On/Off · Kosketuskäyttöinen On/Off ·
Funkcja dotykowa On/Off



Ohne Leuchtmittel · Lamp(s) excluded
Sans ampoule(s) · Zonder lichtbron(nen) ·
Sin bombilla(s) · Lampadina Esclusa · Fara bec (s) ·
Ilman polttimo (s) · Bez żarówki (s)



Memory Funktion · Memory function
fonction mémoire · Geheugen functie ·
Función de memoria · Funzione memorizzazione ·
functia memorie · Muistitoiminto · Funkcja pamięci



indirekte Beleuchtung · indirect lighting
lumière indirecte · indirecte belichting ·
Iluminación indirecta · Illuminazione a scomparsa ·
iluminat indirect · epäsuora valaistus ·
oświetlenie pośrednie



Bewegungssensor · Motion sensor
Détecteur de mouvement · Bewegungssensor ·
Sensor de movimiento · Sensore di movimento ·
Senzor de mișcare · Liiketunnistin · Czujnik ruchu



Dämmerungssensor · Dusk sensor
Détecteur de crépuscule · Schemeringsensor ·
Sensor de oscuridad · Sensore crepuscolare ·
Senzor de lumina/amurg · Hämärätunnistin ·
Czujnik zmierzchowy



Helligkeit einstellbar · Adjustable light level
Niveau d'éclairage ajustable · Instelbaar
lichtniveau · Nivel de luz ajustable · Livello di luce rego-
labile · Nivelul de lumina reglabil · Säädettävä valo taso ·
Regulowana jasność światła



Bluetooth Lautsprecher · Bluetooth loudspeaker
Haut-parleur bluetooth · Bluetooth luidspreker ·
Altavoz de bluetooth · Altoparlante bluetooth ·
Difuzor Bluetooth · Bluetooth-kaiutin ·
Głośnik Bluetooth



USB Anschluss · USB connection
Entrée USB · USB aansluiting · Conexión USB ·
Connessione USB · Conexiune USB · USB-liitäntä ·
Połączenie USB



USB-C Anschluss · USB-C connection
Entrée USB-C · USB-C-aansluiting · Conexión USB-C ·
Connessione USB-C · Conexiune USB-C ·
USB-C-liitäntä · Połączenie USB-C



Akkubetrieb · Rechargeable battery operated
Fonctionnement sur batteries rechargeables ·
Werkt op herlaadbare batterijen · Batería recargable ·
Batteria Ricaricabile · Operabil prin baterie reîncarcabilă ·
Ladattava akku · Akumulator zasilany baterijnie



Solar · Solar
Solaire · Solair · Solar · Solare ·
Solar · Aurinkokenno · Solar



Timer · Timer
Minuterie · Timer · Temporizador · Timer ·
Temporizator · ajastin · Timer



Inklusive Ladestation · Charging station included
Station de recharge incluse · Laadstation inbegrepen ·
Estación de carga incluida · Stazione di ricarica inclusa ·
Stație de încărcare inclusă · Latausasema sisältyy ·
W zestawie stacja ładowająca



Ladezeit · Charging time
Temps de charge · Oplaaadtijd · Tiempo de carga ·
Tempo di carica · Timp de încarcare · Latausaika ·
Czas ładowania



Leuchtdauer · Luminous period
Durée d'éclairage · Brandtijd · Tiempo de
iluminación · Tempo di durata · Perioada de
iluminare · Valaistus aika · Czas świecenia



Bewegungssensor und Orientierungslicht.

Die Leuchte verfügt über ein Orientierungslicht, das sich bei Dämmerung oder Dunkelheit automatisch einschaltet.
Wird eine Bewegung erfasst, schaltet die Leuchte von Orientierungslicht auf volle Lichtleistung

Motion sensor and orientation light .

The luminaire has an orientation light that switches on automatically at dusk or in the dark.
If movement is detected, the luminaire switches from orientation light to full light output.

Capteur de mouvement et lumière d'orientation.

Le luminaire est muni d'une lumière d'orientation qui s'allume automatiquement dès qu'il fait sombre ou dans le noir.
Si un mouvement est détecté, le luminaire passe de la lumière d'orientation à la lumière maximale.

Bewegingssensor en oriëntatielicht.

Het verlichtingstoestel heeft een oriëntatielicht dat automatisch inschakelt bij schemerdonker of in het donker.
Wanneer beweging waargenomen wordt, schakelt het verlichtingstoestel over van oriëntatielicht naar volledig
lichtvermogen.

Lámpara con sensor de movimiento y de orientación.

La lámpara dispone de una luz de orientación que se enciende automáticamente al anoecer o en la oscuridad.
Si se detecta movimiento, la lámpara pasa de luz de orientación a plena potencia luminosa.

Sensore di movimento e luce di orientamento.

La lampada è dotata di una luce di orientamento che si accende automaticamente al crepuscolo o al buio.
Se viene rilevato un movimento, la lampada passa dalla luce di orientamento alla piena emissione di luce.

Senzor de mișcare și lumină de orientare.

Corpul de iluminat are o lumină de orientare care se pornește automat în amurg sau în întuneric.
Dacă este detectată mișcare, corpul de iluminat trece de la lumina de orientare la iluminat deplin.

Liiketunnistin ja suuntavallo.

Valaisimessa on suuntavallo, joka syttyy automaattisesti illansarastuksessa tai pimeään laskiessa.
Jos liikettä havaitaan, valaisin siirtyy suuntavalosta täyteen valaistustehoon.

Czujnik ruchu i światło orientacyjne.

Oprawa posiada światło orientacyjne, które włącza się automatycznie o zmierzchu lub w ciemności.
W przypadku wykrycia ruchu oprawa przełącza się ze światła orientacyjnego na pełną moc świetlną.



Abstrahlwinkel · Emission angle
Angle de rayonnement · Uitstraalhoek ·
Ángulo de emisión · Angolo di emissione ·
Unghiul de emisii · Säteilykulma · Kąt emisji



Belastbaarheid · Resilience
Limite de charge · Belastbaarheid · Resistencia ·
Resistenza · Rezistența la solicitare ·
Kuormittavuus · Nośność



Magnetisch · Magnetic
Magnétique · Magnetisch · Magnético · Magnetic ·
Magnetic · Magneettinen · Magnetyczny



Mini GU10



Inkl. Hausnummern-Set ·
incl. set of house numbers
avec jeu de numéros de maison · incl. set huisnummers ·
incl. juego de números de casa · incl. set di numeri civici ·
incl. set de numere de casă · sis. talon numerosarjan ·
w tym zestaw numerów domów



Stoßfest gemäß IK10 · Shock-resistant according to IK10
Résistance aux chocs selon IK10 · Slagvast volgens IK10 ·
Resistente a impactos según IK10 · Resistente agli urti
secondo IK10 · Rezistent la impact în conformitate cu IK10 ·
Iskunkestävä IK10:n mukaan · Odporność na uderzenia
zgodnie z IK10



Bewegungssensor Multi-Control

Der integrierte Bewegungssensor der Hauptleuchte kann eine bestimmte Anzahl weiterer Leuchten mitsteuern. Die zusätzlichen Leuchten empfangen das Signal der Hauptleuchte und benötigen daher keinen eigenen Sensor.

Multi-Control motion sensor

The integrated motion sensor of the main light can also control a certain number of additional lights. The additional lights receive the signal from the main light and therefore do not require their own sensor.

Capteur de mouvement Multi-Control

Le capteur de mouvement intégré du luminaire principal peut également commander un certain nombre de luminaires supplémentaires. Les luminaires supplémentaires reçoivent le signal du luminaire principal et n'ont donc pas besoin de leur propre capteur.

Multi-Control bewegingssensor

De geïntegreerde bewegingssensor van de hoofdlamp kan ook een bepaald aantal extra lampen aansturen. De extra lampen ontvangen het signaal van de hoofdlamp en hebben dus geen eigen sensor nodig.

Sensor de movimiento Multi-Control

El sensor de movimiento integrado de la luz principal también puede controlar un cierto número de luces adicionales. Las luces adicionales reciben la señal de la luz principal y, por tanto, no necesitan su propio sensor.

Sensore di movimento Multi-Control

Il sensore di movimento integrato nella luce principale può controllare anche un certo numero di luci aggiuntive. Le luci supplementari ricevono il segnale dalla luce principale e non necessitano quindi di un proprio sensore.

Senzor de mișcare Multi-Control

Senzorul de mișcare integrat al luminii principale poate controla, de asemenea, un anumit număr de lumini suplimentare. Luminile suplimentare primesc semnalul de la lumina principală și, prin urmare, nu au nevoie de un senzor propriu.

Multi-Control liiketunnistin

Päävalon integroitu liiketunnistin voi ohjata myös tiettyä määrää lisävaloja. Lisävalot saavat signaalin päävalosta, joten ne eivät tarvitse omaa tunnistinta.

Czujnik ruchu Multi-Control

Zintegrowany czujnik ruchu głównego światła może również sterować pewną liczbą dodatkowych światel. Dodatkowe światła odbierają sygnał z głównego światła i dlatego nie wymagają własnego czujnika.



Inkl. Verbinder für Reihenschaltung

Der Anschlusskasten dieser Leuchten ist so ausgelegt, dass er zwei Anschlussleitungen aufnehmen kann. Dadurch lassen sich mehrere Leuchten problemlos in Reihe schalten.

Connector for series connection included

The connection box of these lights is designed to accommodate two connection cables. This means that several lights can be easily connected in series.

Connecteur pour connexion en série inclus

Le boîtier de raccordement de ces luminaires est conçu de manière à pouvoir accueillir deux câbles de raccordement. Il est ainsi possible de brancher plusieurs luminaires en série sans problème.

Connector voor serieaansluiting inbegrepen

De aansluitdoos van deze lampen is zo ontworpen dat er twee aansluitkabels in passen. Dit betekent dat meerdere lampen eenvoudig in serie kunnen worden aangesloten.

Conector para conexión en serie incluido

La caja de conexiones de estas luces está diseñada para alojar dos cables de conexión. Esto permite conectar fácilmente varias luces en serie.

Connettore per il collegamento in serie incluso

La scatola di connessione di queste luci è progettata per ospitare due cavi di collegamento. In questo modo è possibile collegare facilmente più luci in serie.

Conector pentru conectarea în serie inclus

Cuția de conexiuni a acestor lumini este proiectată pentru a găzdui două cabluri de conexiune. Acest lucru înseamnă că mai multe lumini pot fi conectate cu ușurință în serie.

Mukana liitin sarjakytkentää varten

Näiden valaisimien liitäntäkotelot on suunniteltu siten, että siihen mahtuu kaksi liitäntäkappaletta. Tämä tarkoittaa, että useita valoja voidaan helposti kytkeä sarjaan.

W zestawie złącze do połączenia szeregowego

Skrzynka połączeniowa tych światel została zaprojektowana tak, aby pomieścić dwa kable połączeniowe. Oznacza to, że kilka lamp można łatwo połączyć szeregowo.



Geeignet für Küstengebiete 10 Jahre

10 Jahre Garantie auf Korrosionsschutz bei Leuchten aus pulverbeschichtetem Aluminium. Ausgenommen sind Ausbleichen der Oberfläche sowie technische Komponenten.

Seaside ready (10 years)

10-year guarantee on corrosion protection for luminaires made of powder-coated aluminum. This excludes fading of the surface and technical components.

Seaside ready (10 ans)

10 ans de garantie contre la corrosion pour les luminaires en aluminium thermolaqué. Sont exclus la décoloration de la surface ainsi que les composants techniques.

Klaar voor de kust (10 jaar)

10 jaar garantie op corrosiebescherming voor armaturen gemaakt van gepoedercoat aluminium. Dit sluit verbleking van het oppervlak en technische onderdelen uit.

Seaside ready (10 años)

10 años de garantía de protección contra la corrosión para luminarias de aluminio con recubrimiento de polvo. Esto excluye la decoloración de la superficie y los componentes técnicos.

Seaside ready (10 anni)

Garanzia di 10 anni sulla protezione dalla corrosione per gli apparecchi di illuminazione in alluminio verniciato a polvere. Questo esclude lo sbiadimento della superficie e dei componenti tecnici.

Seaside ready (10 ani)

Garanție de 10 ani privind protecția împotriva coroziunii pentru corpurile de iluminat din aluminiu acoperit cu pulbere. Aceasta exclude decolorarea suprafeței și a componentelor tehnice.

Seaside ready (10 vuotta)

10 vuoden korroosiosuojatarkkuu jauhemaalatasta alumiinista valmistetuille valaisimille. Tämä ei koske pinnan ja teknisten osien haalistumista.

Seaside ready (10 lat)

10-letnia gwarancja na ochronę antykorozyjną opraw oświetleniowych wykonanych z aluminium malowanego proszkowo. Nie obejmuje to blaknięcia powierzchni i elementów technicznych.



Geeignet für Küstengebiete 15 Jahre

15 Jahre Garantie auf Korrosionsschutz bei Leuchten aus feuerverzinktem Edelstahl. Ausgenommen sind Ausbleichen der Oberfläche sowie technische Komponenten.

Seaside ready (15 years)

15-year guarantee on corrosion protection for luminaires made of hot-dip galvanized stainless steel. This excludes fading of the surface and technical components.

Seaside ready (15 ans)

15 ans de garantie contre la corrosion pour les luminaires en acier inoxydable galvanisé à chaud. Sont exclus la décoloration de la surface ainsi que les composants techniques.

Klaar voor de kust (15 jaar)

15 jaar garantie op corrosiebescherming voor armaturen gemaakt van thermisch verzinkt roestvrij staal. Dit sluit verbleking van het oppervlak en technische onderdelen uit.

Seaside ready (15 años)

15 años de garantía de protección contra la corrosión para luminarias de acero inoxidable galvanizado en caliente. Esto excluye la decoloración de la superficie y los componentes técnicos.

Seaside ready (15 anni)

Garanzia di 15 anni sulla protezione dalla corrosione per gli apparecchi di illuminazione in acciaio inox zincato a caldo. Questo esclude lo sbiadimento della superficie e dei componenti tecnici.

Seaside ready (15 ani)

Garanție de 15 ani privind protecția împotriva coroziunii pentru corpurile de iluminat din oțel inoxidabil galvanizat la cald. Aceasta exclude decolorarea suprafeței și a componentelor tehnice.

Seaside ready (15 vuotta)

15 vuoden korroosiosuojatarkkuu kuumasinkitystä ruostumattomasta teräksestä valmistetuille valaisimille. Tämä ei koske pinnan ja teknisten osien haalistumista.

Seaside ready (15 lat)

15-letnia gwarancja na ochronę antykorozyjną opraw oświetleniowych wykonanych ze stali nierdzewnej ocynkowanej ognioowo. Nie obejmuje to blaknięcia powierzchni i elementów technicznych.



D Schutzklasse 1

Leuchten für den Anschluss an den netzseitigen Schutzleiter.
Das Symbol ist an der Anschlussstelle angebracht.

GB Protection grade I:

Lamps for connection to network safety conductors.
The symbol is placed at the connection port.

FR Degré de protection I:

Les lampes qui ont une connexion avec la prise de terre.
Les lampes qui ont une connexion avec la prise de terre.

NL Beschermlasse I:

Lampen voor aansluiting op de netzijdige
veiligheidsaarddraad.
Het symbool is op het aansluitpunt aangebracht.

ES Protección tipo I:

Lámparas para conectar en redes de conductores seguros.
El símbolo está indicado en el conector.

IT Classe di protezione I:

Apparecchi con parti metalliche costantemente
collegate al circuito di terra. Il simbolo è riportato sul
punto di collegamento.

RO Protectie grad I:

Lampile care au conectare cu priza de pamant.
Simbolul este plasat la punctul de conectare.

FI Suojausluokka I:

Valaisimet, jotka liitetään verkon turvamaadoitukseen.
Symboli on merkitty liitännäkohtaan.

PL Klasa ochrony I:

Oprawy przystosowane do podłączenia przewodu
ochronnego. Oznakowanie znajduje się w miejscu
podłączenia.



D Schutzklasse 2

Leuchten für den Betrieb mit Schutzkleinspannung.

GB Protection grade II:

Protected low voltage lamps.

FR Degré de protection II:

Les lampes protégées à faible voltage.

NL Beschermlasse II:

Lampen voor het gebruik met veiligheidslaagspanning.

ES Protección tipo II:

Lámparas de bajo voltaje con protección.

IT Classe di protezione II:

Apparecchi alimentati con tensione di sicurezza
inferiore ai 50 V.

RO Protectie grad II:

Lampi protejate la tensiune joasa.

FI Suojausluokka II:

Valaisimet, joita käytetään suojapienjännitteellä.

PL Klasa ochrony II:

Oprawy przeznaczone do zasilania z sieci o
niskim napięciu bezpiecznym.



D Schutzklasse 3

Leuchten mit einer zusätzlichen oder verstärkten
Isolierung. Sie haben keinen Schutzleiteranschluss.

GB Protection grade III:

Lamps with additional or reinforced insulation.
There is no connection for the safety conductor.

FR Degré de protection III:

Les lampes ayant une isolation supplémentaire ou
renforcée. Il n'y a pas de connexion pour le
conducteur de protection.

NL Beschermlasse III:

Lampen met een extra of versterkte isolatie.
Ze hebben geen veiligheidsaarddraadaansluiting.

ES Protección tipo III:

Lámparas con aislamiento adicional o reforzado.
No tiene conexión con el conductor de seguridad.

IT Classe di protezione III:

Apparecchi con parti in tensione isolate fra loro e
verso l'esterno con un doppio isolamento e senza
dispositivi di messa a terra.

RO Protectie grad III:

Lampi care au o izolatie suplimentara sau ranforsata.
Nu exista o conexiune pentru conductorul de siguranta.

FI Suojausluokka III:

Valaisimet, joissa on lisäeristys tai vahvistettu eristys.
Niissä ei ole turvamaadoitusliitännää.

PL Klasa ochrony III:

Oprawy przystosowane do podłączenia przewodu
ochronnego. Oznakowanie znajduje się w miejscu
podłączenia.

Farben & Materialien · Colours and materials

Couleurs et matériaux · Kleuren en materialen · Colores y materiales · Colori e materiali ·
Culori si materiale · Värit ja materiaalit · Kolory i materiały

01 Weiß · white

blanc · wit · blanco · bianco · alb · valkoinen · biały

02 Schwarz · black

noir · zwart · negro · nero · negru · musta · czarny

07 Nickel matt · nickel mat

nickel mat · nikkel mat · níquel mate · nichel opaco ·
nichel mat · harjattu teräs · nikiel mat

10 Rot · red

rouge · rood · rojo · rosso · rosu ·
punainen · czerwony

11 Grau · grey

gris · grijs · gris · grigio · gri · harmaa · popielaty

15 Grün · green

vert · groen · verde · verde · verde · vihreä · zielony

24 rostfarbig · rusty

rouille · roestkleur · óxido · ruggine · ruginiu ·
rustiikki · miedź

28 rostfarbig antik · antique rust

rouille antique · roestkleur antiek · oxido · ruggine anticato ·
ruginiu antic · rustiikki · antyczny rdzawy

31 Weiß matt · white mat

blanc mat · wit mat · estera blanca · bianco opaco ·
alb mat · valkoinen matto · biały mat

32 Schwarz matt · black mat

noir mat · mat zwart · estera negra · nero opaco ·
negru mat · musta matto · czarny mat

35 Holznachbildung · wood imitation

imitation bois · houtimitatie · imitación de madera ·
effetto legno · imitație de lemn · puujäljitelmä ·
imitacja drewna

40 Apricot · apricot

abricot · abrikoos · albaricoque · apricot ·
caise · aprikoosi · morela

42 Anthrazit · anthracite

antracite · antraciet · antracita · antracite · antracit ·
antrasiitti · antracyt

49 Pistaziengrün · pistachio green

vert pistache · pistachegroen · verde pistacho ·
verde pistacchio · verde fistic · pistaasin vihreä ·
zielony pistacjowy

65 Coffee · coffee

café · koffie · café · caffè · cafea · antiikkiteräs · kawa

66 Sand · sable

zand · arena · sabbia · nisip · hiekka · piaskowy · kum

77 Ultimate Grau · ultimate grey

gris ultimate · ulziem grijs · gris absoluto ·
grigio assoluto · gri suprem · ultimaattinen harmaa ·
ciemnoszary

83 Illuminate Gelb · illuminate yellow

jaune illuminate · helder geel · amarillo iluminado ·
giallo brillante · galben strălucitor · hehkuvan keltainen ·
swietlisty żółty

86 zinkfarbig · zinc-colored

couleur zinc · zink kleur · color zinc · color Zinco ·
culoarea zincului · antiikkiihopea · kolor cynkowy

Seite Page	Artikel-Nr. Product No.	EAN-Nummer EAN-Number	Seite Page	Artikel-Nr. Product No.	EAN-Nummer EAN-Number
102	201760124	4017807442021	82	222260124	4017807410594
102	201760131	4017807687354	85	222260132	4017807603620
102	201760142	4017807445411	78	222260142	4017807382570
96	201860124	4017807687378	82	222260224	4017807410587
96	201860131	4017807647525	85	222260232	4017807603637
96	201860142	4017807433210	78	222260242	4017807382587
96	201860224	4017807687392	84	224060132	4017807603583
96	201860231	4017807647549	80	224060142	4017807434330
96	201860242	4017807442410	84	224060232	4017807603590
95	201869142	4017807603378	80	224060242	4017807434347
112	201960124	4017807442045	24	226260142	4017807492545
112	201960142	4017807442052	34	226360142	4017807492347
113	202360124	4017807449891	34	226369142	4017807492354
113	202360142	4017807442069	41	226460242	4017807415612
114	202760124	4017807445589	52	226560242	4017807408539
114	202760142	4017807449884	42	226660242	4017807388893
92	204160124	4017807413939	42	226669242	4017807388817
94	204160131	4017807492408	40	226860242	4017807382839
94	204160135	4017807647587	43	226960231	4017807382259
90	204160142	4017807413946	43	226960242	4017807382266
93	204169124	4017807492446	49	227260142	4017807369236
94	204169131	4017807492422	48	227360142	4017807369229
94	204169135	4017807647600	41	227560231	4017807337570
91	204169142	4017807492460	41	227560242	4017807337594
58	204260224	4017807519006	41	227660231	4017807337600
58	204260231	4017807518986	41	227660242	4017807337617
58	204260242	4017807453171	48	228060142	4017807281569
58	204269224	4017807519044	45	228260142	4017807279535
58	204269231	4017807519020	52	228460242	4017807284164
58	204269242	4017807453195	45	228560242	4017807356984
108	205760131	4017807693690	44	228669142	4017807356656
108	205760132	4017807543407	53	229160142	4017807242126
108	205767131	4017807693683	40	229360242	4017807242164
108	205767132	4017807543414	22	230561142	4017807648522
104	205960128	4017807543575	23	230569142	4017807648539
104	205967128	4017807543582	20	238560142	4017807686807
54	206060142	4017807490480	20	238569142	4017807686821
106	206960132	4017807543810	14	238660142	4017807686876
106	206967132	4017807543803	14	238669142	4017807686890
102	207269124	4017807492613	12	240960142	4017807563993
70	207360142	4017807492675	12	240969142	4017807564006
64	209760107	4017807556551	38	245560142	4017807603392
64	209760132	4017807648201	38	245569142	4017807603408
64	209769107	4017807693744	29	246360142	4017807603484
64	209769132	4017807648218	29	246360242	4017807603491
88	211060142	4017807506174	29	246360342	4017807603507
88	211069142	4017807506198	35	246860142	4017807603569
66	211660132	4017807564075	35	246869142	4017807603576
68	211660135	4017807603439	18	246960135	4017807603705
114	212060142	4017807529272	18	246969135	4017807603712
114	212069142	4017807529289	16	247060142	4017807603767
44	212160242	4017807529340	17	247069142	4017807603774
53	212560232	4017807564044	28	247360242	4017807603798
56	214260142	4017807529210	146	253569142	4017807622478
56	214260242	4017807529234	148	253769142	4017807622508
56	214269142	4017807529227	50	260260224	4017807691320
56	214269242	4017807529241	50	260260231	4017807691344
103	218260124	4017807691276	50	260260242	4017807691306
103	218260142	4017807691177	55	260360131	4017807691566
43	218560231	4017807647563	55	260360142	4017807691412
43	218560235	4017807603477	100	260560186	4017807691719
43	218560242	4017807603460	100	260660286	4017807691887
32	220760142	4017807259063	101	261060186	4017807691672
42	220969142	4017807259315	98	262060186	4017807687675
30	221160142	4017807302004	98	262067186	4017807687699
31	221169142	4017807279290	115	262260124	4017807648287
39	221460142	4017807490473	115	262260131	4017807648294
39	221460242	4017807564037	115	262260142	4017807648270

Seite Page	Artikel-Nr. Product No.	EAN-Nummer EAN-Number	Seite Page	Artikel-Nr. Product No.	EAN-Nummer EAN-Number
61	262360115	4017807648454	81	424067142	4017807445404
61	262360124	4017807648430	24	426260142	4017807492576
61	262360140	4017807648461	22	430561142	4017807648553
61	262360142	4017807648423	20	438560142	4017807686852
61	262360166	4017807648447	20	438569142	4017807686869
60	262460115	4017807648508	14	438660142	4017807686920
60	262460124	4017807648485	14	438669142	4017807686937
60	262460140	4017807648515	12	440969142	4017807564020
60	262460142	4017807648478	18	446960135	4017807603736
60	262460166	4017807648492	16	447060142	4017807603750
74	262560135	4017807648560	146	453569142	4017807622492
72	262560178	4017807650235	149	453769142	4017807622522
74	262569135	4017807648577	55	460360131	4017807691634
72	262569178	4017807650242	55	460360142	4017807691450
110	263260131	4017807648119	98	462060186	4017807687736
110	263260132	4017807648102	74	462560135	4017807648591
110	263260231	4017807648133	72	462560178	4017807650266
110	263260232	4017807648126	62	469460142	4017807687064
111	263260331	4017807648195	76	469860142	4017807687309
111	263260332	4017807648188	76	469869142	4017807687323
62	269460142	4017807686944	26	477860142	4017807564112
62	269460242	4017807686982	97	501860142	4017807433234
62	269469142	4017807690965	92	504160124	4017807413977
51	269560131	4017807687125	90	504160142	4017807413991
51	269560142	4017807687101	58	504260142	4017807453218
51	269560231	4017807687163	108	505760131	4017807693720
51	269560242	4017807687149	108	505760132	4017807543421
50	269760224	4017807687477	104	505960128	4017807543599
50	269760231	4017807687453	54	506060142	4017807490497
50	269760242	4017807687439	106	506960132	4017807543827
76	269860142	4017807687187	70	507360142	4017807492705
76	269869142	4017807687200	64	509760107	4017807556575
36	270660142	4017807529111	64	509760132	4017807648225
36	270660242	4017807529159	66	511660132	4017807564082
37	270669142	4017807529135	68	511660135	4017807603446
37	270669242	4017807529166	56	514260142	4017807529258
26	277860142	4017807529333	86	520060142	4017807241563
111	363260131	4017807648171	32	520760142	4017807259100
111	363260132	4017807648164	30	521160142	4017807351590
97	401860142	4017807433258	31	521169142	4017807279313
95	401869142	4017807603385	82	522260124	4017807410563
92	404160124	4017807413953	78	522260142	4017807382594
90	404160142	4017807413960	84	524060132	4017807603606
92	404160324	4017807648317	80	524060142	4017807434354
90	404160342	4017807648300	24	526260142	4017807492569
58	404260142	4017807453232	22	530561142	4017807648546
108	405760132	4017807543445	20	538560142	4017807686838
108	405760332	4017807543452	20	538569142	4017807686845
104	405960128	4017807543605	14	538660142	4017807686906
104	405960328	4017807543612	14	538669142	4017807686913
106	406960132	4017807543834	12	540969142	4017807564013
106	406960332	4017807543841	18	546960135	4017807603729
70	407360142	4017807492729	16	547060142	4017807603743
64	409760107	4017807556599	146	553569142	4017807622485
64	409760132	4017807687415	149	553769142	4017807622515
88	411060142	4017807506211	55	560360131	4017807691597
88	411060342	4017807506228	55	560360142	4017807691436
66	411660132	4017807564099	98	562060186	4017807687712
68	411660135	4017807603453	74	562560135	4017807648584
56	414260142	4017807529265	72	562560178	4017807650259
86	420060142	4017807241792	110	563260131	4017807648157
32	420760142	4017807259087	110	563260132	4017807648140
30	421160142	4017807351583	62	569460142	4017807687026
31	421169142	4017807279306	76	569860142	4017807687262
82	422260124	4017807410570	76	569869142	4017807687286
78	422260142	4017807382600	26	577860142	4017807564105
84	424060132	4017807603613	96	601860242	4017807442397
80	424060142	4017807434361	46	630369142	4017807648348

Seite Page	Artikel-Nr. Product No.	EAN-Nummer EAN-Number	Seite Page	Artikel-Nr. Product No.	EAN-Nummer EAN-Number
46	630369242	4017807648355	126	R28222631	4017807408324
47	676960142	4017807453416	126	R28222632	4017807411775
26	677860142	4017807529326	127	R28232631	4017807408317
117	800260142	4017807453133	127	R28232632	4017807411768
117	800260342	4017807453157	176	R35146132	4017807529432
116	821660107	4017807453287	164	R42251142	4017807452709
116	821660207	4017807453348	164	R42261142	4017807452730
119	9960-07	4017807259360	150	R43286132	4017807648003
118	9962-11	4017807305784	122	R43356142	4017807648409
118	9964-42	4017807445299	152	R44676132	4017807622430
119	9965-32	4017807472349	186	R45101101	4017807500295
134	R21186131	4017807564136	186	R45101901	4017807500301
134	R21186132	4017807564129	140	R45853632	4017807697575
138	R21596124	4017807603828	140	R45863632	4017807697599
138	R21596131	4017807603804	180	R47706131	4017807601749
138	R21596132	4017807603811	180	R47706132	4017807601756
128	R22052142	4017807490428	180	R47706149	4017807601763
128	R22062142	4017807490435	180	R47706166	4017807643220
166	R22106132	4017807650488	183	R52176101	4017807496314
166	R22109132	4017807650495	183	R52176102	4017807496338
136	R22151142	4017807453546	183	R52176149	4017807541236
169	R22189132	4017807650563	183	R52176183	4017807541229
167	R22231107	4017807458220	150	R53286132	4017807647990
167	R22231142	4017807452648	122	R53356142	4017807648416
164	R22251142	4017807452686	182	R54096131	4017807564327
164	R22261142	4017807452723	182	R54096132	4017807564334
167	R22281142	4017807452754	182	R54096631	4017807601671
130	R23056142	4017807647907	182	R54096632	4017807601688
130	R23056242	4017807647914	182	R54099602	4017807610376
168	R23066101	4017807647921	185	R54106110	4017807601817
168	R23146101	4017807647938	185	R54106131	4017807601787
162	R23156102	4017807647945	185	R54106132	4017807601794
162	R23166101	4017807647952	185	R54106149	4017807601800
163	R23176102	4017807647969	185	R54106165	4017807633900
150	R23286132	4017807647983	152	R54676132	4017807622423
154	R23306101	4017807648027	189	R55086101	4017807444421
154	R23306102	4017807648010	172	R55326101	4017807492101
158	R23326102	4017807648034	172	R55326901	4017807492125
155	R23336201	4017807648041	184	R55961131	4017807644777
155	R23336202	4017807648058	184	R55961132	4017807644784
132	R23346132	4017807648065	184	R55961149	4017807644807
132	R23346232	4017807648072	184	R55961166	4017807644791
132	R23349132	4017807648089	184	R55961177	4017807644814
132	R23349232	4017807648096	142	R57042001	4017807282801
122	R23356142	4017807648386	142	R57043001	4017807282818
122	R23359142	4017807648393	142	R57044001	4017807282825
152	R24676132	4017807622416	188	R57080101	4017807407556
159	R24696132	4017807622539	180	R57706131	4017807601701
156	R24706132	4017807622546	180	R57706132	4017807601718
157	R24716132	4017807622553	180	R57706149	4017807601725
158	R24746232	4017807622577	180	R57706166	4017807643244
171	R25119631	4017807691610	136	R60501031	4017807405873
171	R25119632	4017807691658	136	R60501042	4017807405910
170	R25129631	4017807691528	136	R62151142	4017807405989
170	R25129632	4017807691542	176	R74761132	4017807622607
131	R26446232	4017807648232	177	R74761932	4017807650693
135	R26456132	4017807648249	192	R74771132	4017807622720
135	R26459132	4017807648256	191	R74771532	4017807697612
139	R26476124	4017807648331	193	R74771932	4017807650648
139	R26476142	4017807648324	190	R74938602	4017807687767
131	R26931631	4017807691474	174	R83256332	4017807647976
131	R26931632	4017807691498	175	R84756232	4017807622584
125	R26961632	4017807687507	143	R86466102	4017807648263
125	R26962632	4017807687521	143	R86871042	4017807687910
124	R26971631	4017807687552			
124	R26971632	4017807687576			
129	R27026132	4017807529357			
129	R27036132	4017807529364			

TRIO Leuchten GmbH

Gut Nierhof 17
D-59757 Arnsberg
T +49 (0) 2931 9666-0
F +49 (0) 2931 9666-57
info@trio-leuchten.de
www.trio-leuchten.de

Reality Leuchten GmbH

Gut Nierhof 17
D-59757 Arnsberg
T +49 (0) 2931 9666-99
F +49 (0) 2931 9666-98
info@reality-leuchten.de
www.reality-leuchten.de

TRIO International GmbH

Gut Nierhof 17
D-59757 Arnsberg
T +49 (0) 2931 9666-587
F +49 (0) 2931 9666-56
info@trio-lighting.com
www.trio-lighting.com

Baden Württemberg, Rheinland-Pfalz, Saarland

Antonio De Simone
T +49 (0) 151 5855222
antonio.desimone@trio-leuchten.de

Bayern, Hessen

Martin Kluge
T +49 (0) 171 7300330
martin.kluge@trio-leuchten.de

Berlin, Brandenburg, Mecklenburg-Vorpommern, Sachsen, Sachsen-Anhalt, Thüringen

Jörg Bumke
T +49 (0) 160 7406860
joerg.bumke@trio-leuchten.de

Bremen, Hamburg, Niedersachsen, Schleswig-Holstein

Jens Gebers
T +49 (0) 170 1615227
jens.gebers@trio-leuchten.de

Hessen, Nordrhein-Westfalen, Rheinland-Pfalz

Christian Teller
T +49 (0) 171 4521820
christian.teller@trio-leuchten.de

Österreich

Wolfgang Melich
T +43 (0) 660 5161228
wolfgang.melich@trio-leuchten.de

Schweiz

TRIO Leuchten GmbH
T +49 (0) 2931 9666-0
info@trio-leuchten.de



France

Stéphane Papierny
Directeur commercial France
T +33 9 74 77 07 90
info.france@trio-lighting.com

Maïté Jourdan Casu
Chef des Ventes et Responsable
Comptes clés - France

Sullivan Nicolas
Commercial pour les départements
01, 03, 07, 21, 23, 26, 38, 39, 42, 43, 48, 63,
69, 71, 73 et 74

Vincent Zaepffel
Commercial pour les départements
08, 10, 25, 51, 52, 54, 55, 57, 67, 68, 70,
88 et 90

Christophe Meulien
Agent commercial pour les départements
04, 05, 06, 11, 13, 30, 34, 66, 83, 84 et 98

Jean Barel
Agent commercial pour les départements
09, 12, 15, 16, 19, 24, 31, 32, 33, 40, 46, 47,
64, 65, 81, 82 et 87

Stéphane Kerjean
Agent commercial pour les départements
14, 17, 22, 29, 35, 36, 37, 41, 44, 49, 50, 53, 56,
61, 72, 79, 85 et 86

Stéphane Riebel
Agent commercial pour les départements
18, 27, 28, 45, 58, 75, 76, 77, 78, 89, 91, 92, 93,
94 et 95

Sylvain Martin
Agent commercial pour les territoires
des DROM-COM

Agence Rouquié
Bruno Rouquié
Agent commercial GSB pour les départements
09, 12, 15, 16, 17, 18, 19, 24, 31, 32, 33, 36, 40, 46,
47, 64, 65, 81, 82 et 87

Jean Marc Beneforti
Agent commercial pour les départements
2a et 2b

Daho Bekhti
Agent commercial pour les départements
02, 59, 60, 62 et 80

Agence Nao West
Aymeric Monnet / Marie Lafleuriel
Agent commercial GSB pour les départements
14, 22, 29, 35, 37, 41, 44, 49, 50, 53, 56, 61, 72,
79, 85 et 86

Belgium / Luxemburg

**Yves Van den Berghe / Frank Boesmans /
Pauline Delorme / Wim Deplae**
info.belgium@trio-lighting.com

Denmark

Jan Rantzau-Bartens
info.denmark@trio-lighting.com

Netherlands

Karl Stok / Bas Martin
info.nederland@trio-lighting.com

Romania

Loredana Barbu
T (+40) 741 788 674
loredana.barbu@trio-lighting.com

Great Britain

TRIO Lighting UK Ltd.
KC 28/29 Knowledge Centre
Wyboston Lakes Resort
Great North Road
Wyboston
Bedfordshire
MK44 3AL
T +44 (0) 1268 889 595
F +44 (0) 1268 889 596
sales-uk@trio-lighting.com

Italy

TRIO Lighting Italia s.r.l
Via Isonzo, 81
22066 Mariano Comense (CO)
T +39 (0) 317 477 55
F +39 (0) 313 551 560
commerciale@trio-lighting.com

Nordic and Baltic

TRIO Lighting Scandinavia Oy
Malmin raitti 17, rappu B
00700 Helsinki
T +358 (0) 10 23 13 390
TLS@trio-lighting.com

*Our Scandinavian organisation represents TRIO
in Finland, Sweden, Norway, Iceland, Estonia,
Latvia and Lithuania.*

Spain

TRIO Lighting Ibèrica S.L.
C/VALLESPIR 19, Plta 2, módulo 1.1
08173 Sant Cugat del Vallès
T +34 (0) 935 458 630
info.iberica@trio-lighting.com

Africa

F&M Global
T (+32) 4719 22111
hans.deserranno@fmglobal.be

Ina Concept
T (+32) 4719 94693
jerome.freri@ina-concept.com

Albania

Kika Light
T (+355) 672 084 781
kikallight@gmail.com

Bosnia and Herzegovina

GRIČ d.o.o.
T (+38) 7039 706 658
daniel.martinovic@tel.net.ba

Bulgaria

ATG Bulgaria
T (+359) 899 927 707
deyana_petrova@atg-apa.net

Czech Republic

Luminex spol. s.r.o.
T (+42) 777 570 560
objednavky@luminex.cz

Greece / Cyprus

Solomon Lighting S.A.
T (+30) 21060 46003
alberto@solomongroup.gr

Hungary

Luxera Kft.
T (+36) 83 3163 88
info@trio-lampa.hu

Kosovo

ACN
T (+383) 44 344 434
info@acn-ks.com

North Macedonia

Elektro Megavat
T (+389) 71665006
contact@megalight.com.mk

Poland

Delighting Polska sp. z.o.o.
T (+48) 61 4367 481
kontakt@delighting.pl

Republic of Moldova

Volta LTD
T (+37) 322 26 7775
import5@volta.md

Serbia

Aura Light d.o.o. Novi Sad
T (+38) 121 2100724
aura.lightdoo@gmail.com

Slovakia

Feim SK s.r.o.
T (+42) 134 7743 228
svietidla@feim.sk

Slovenia

BT Trade d.o.o.
T (+386) 41 676 006
info@butiksvetil.si

Türkiye

Soho Aydınlatma Ticaret Ltd.
T (+90) 2165 7669 41
kartal.kendirci@soholight.com

Ukraine

MAX Light
T (+38) 4446 37942
tanya@maxlight.ua

OUTDOOR

TRIO Leuchten GmbH

Gut Nierhof 17
D-59757 Arnsberg
T +49 2931 9666-0
F +49 2931 9666-28
info@trio-leuchten.de
www.trio-leuchten.de

Reality Leuchten GmbH

Gut Nierhof 17
D-59757 Arnsberg
T +49 2931 9666-99
F +49 2931 9666-98
info@reality-leuchten.de
www.reality-leuchten.de

TRIO International GmbH

Gut Nierhof 17
D-59757 Arnsberg
T +49 2931 9666-587
F +49 2931 9666-56
info@trio-lighting.com
www.trio-lighting.com

 /trioleuchten

 @trio.lighting

 @trioleuchten

 @TRIO Lighting Group

 @triolighting

